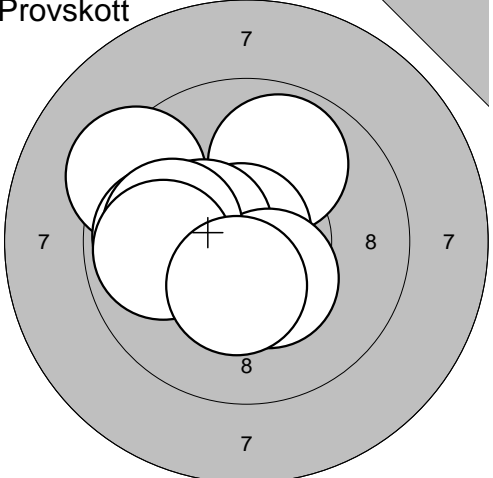
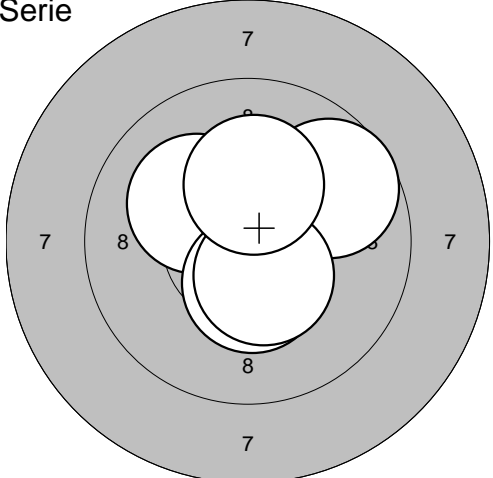
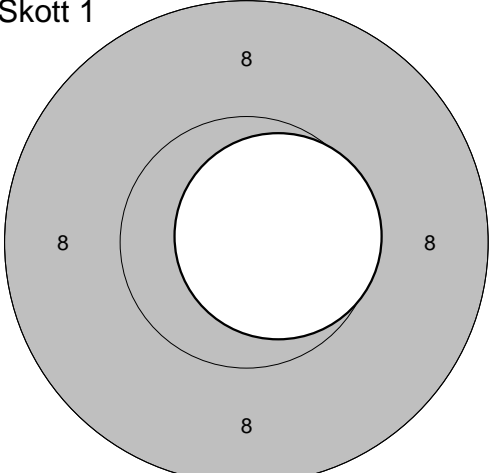
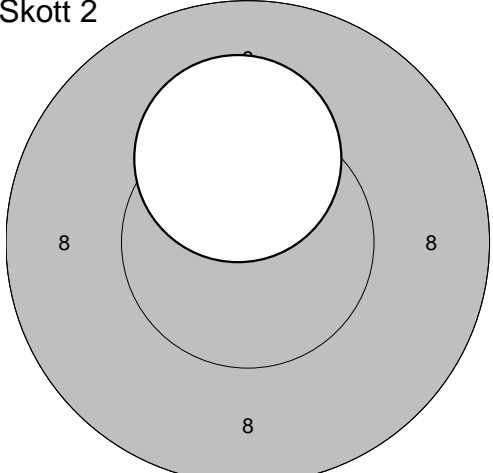
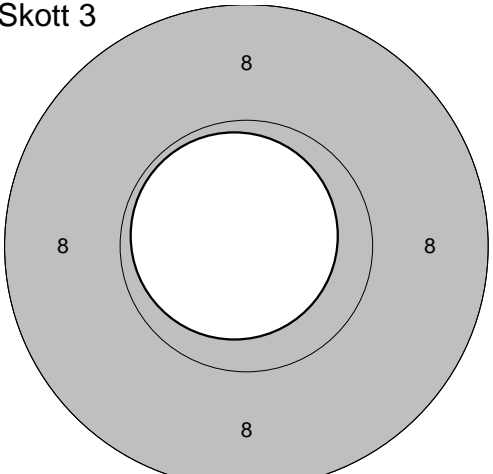
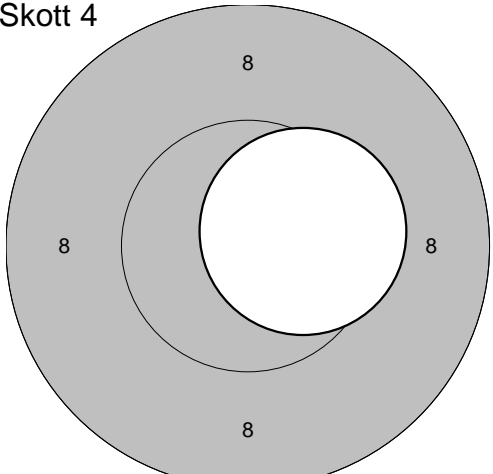
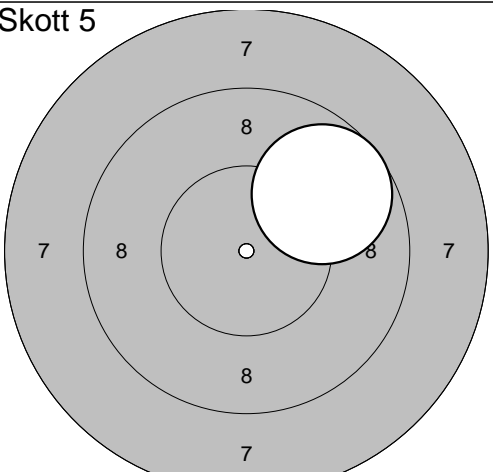
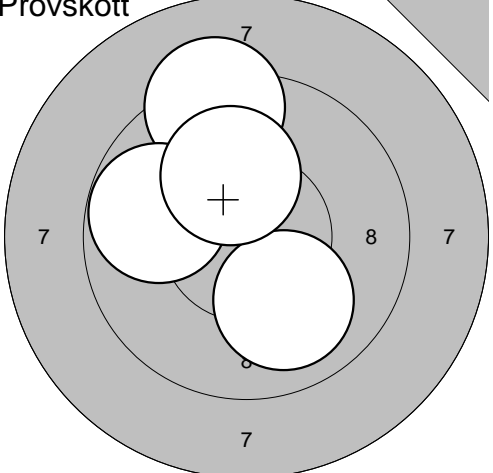
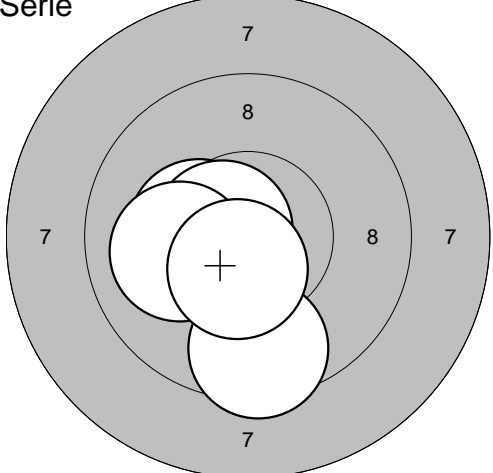

<b>Provskott</b> 	1: 9,9 ↗ 2: 10,8* ↗ 3: 9,3 ↗ 4: 10,4* ↖ 5: 9,9 ← 6: 10,4* ↓ 7: 10,0 ← 8: 9,9 ← 9: 10,4* ↓	<b>Serie</b> 	1: 9,7 ↗ 2: 10,1 ↖ 3: 10,4* ↓ 4: 10,5* ↓ 5: 10,2* ↑
Serie: 91,0		Serie: 50,9	
Summa: 386,0		Summa: 436,9	

<b>Skott 1</b> 	1: 10,7* →	<b>Skott 2</b> 	1: 10,2* ↑
Serie: 10,7		Serie: 10,2	
Summa: 447,6		Summa: 457,8	

<b>Skott 3</b> 	1: 10,8* ↖	<b>Skott 4</b> 	1: 10,5* →
Serie: 10,8		Serie: 10,5	
Summa: 468,6		Summa: 479,1	

<b>Skott 5</b> 	1: 9,7 ↗		
Serie: 9,7			
Summa: 488,8			

<b>Provskott</b> 	1:10,0 ↓ 2: 9,3 ↑ 3: 9,8 ← 4:10,2* ↑	<b>Serie</b> 	1:10,3* ← 2: 9,5 ↓ 3:10,6* ← 4:10,1 ← 5:10,5* ↓
Serie: 39,3 Summa: 385,0		Serie: 51,0 Summa: 436,0	

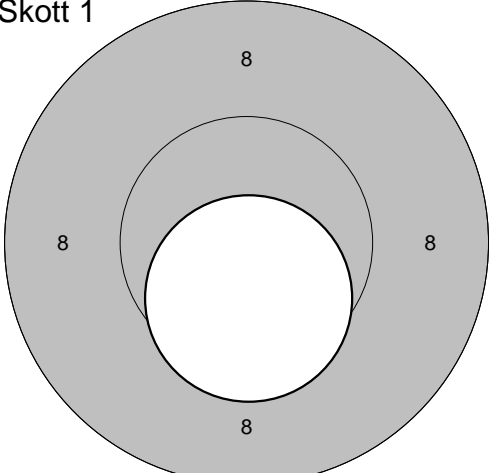
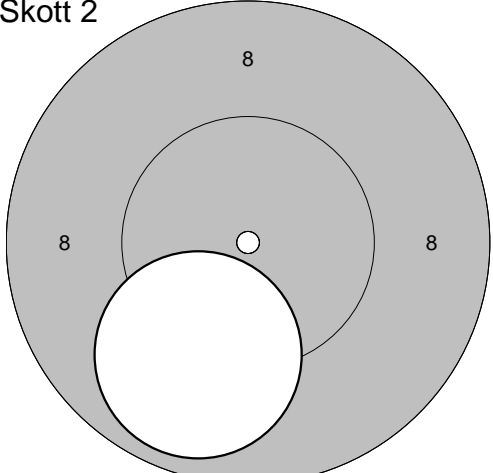
<b>Skott 1</b> 	1:10,5* ↓	<b>Skott 2</b> 	1: 9,9 ↓
Serie: 10,5 Summa: 446,5		Serie: 9,9 Summa: 456,4	

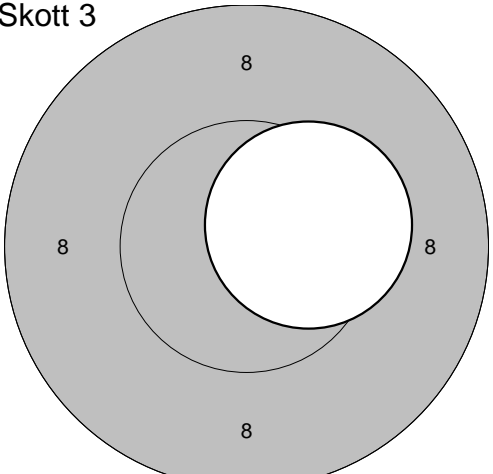
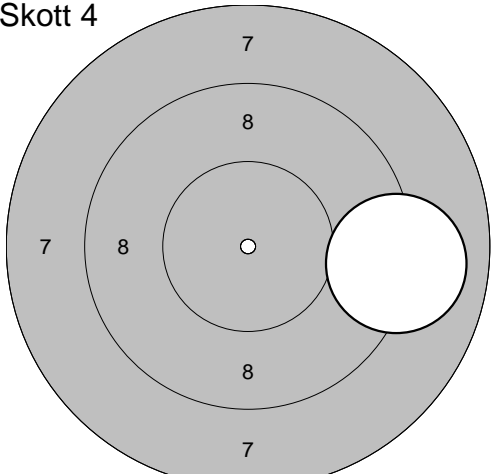
<b>Skott 3</b> 	1:10,4* →	<b>Skott 4</b> 	1: 9,0 →
Serie: 10,4 Summa: 466,8		Serie: 9,0 Summa: 475,8	

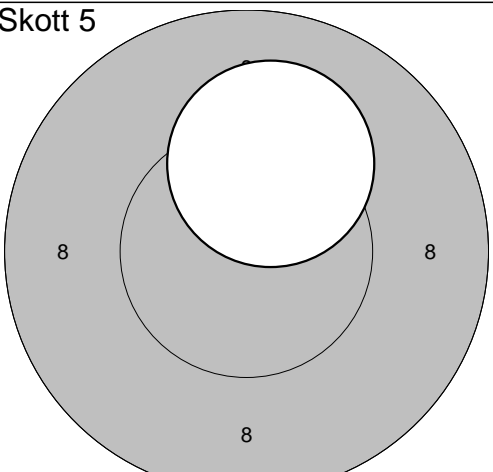
<b>Skott 5</b> 	1:10,2* ↑		
Serie: 10,2 Summa: 486,0			

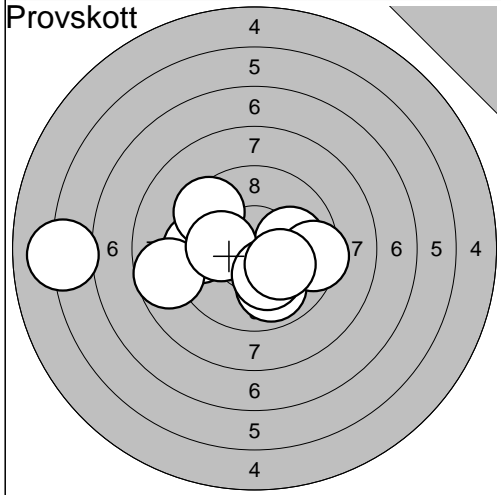

1: 9,6	←
2: 8,7	←
3: 9,9	↘
4: 9,5	↗
5: 10,0	→
6: 10,1	←
7: 10,2*	↘
8: 9,4	→
9: 10,2*	↘
10: 6,1	←
<b>Serie: 93,7</b>	
<b>Summa: 365,0</b>	

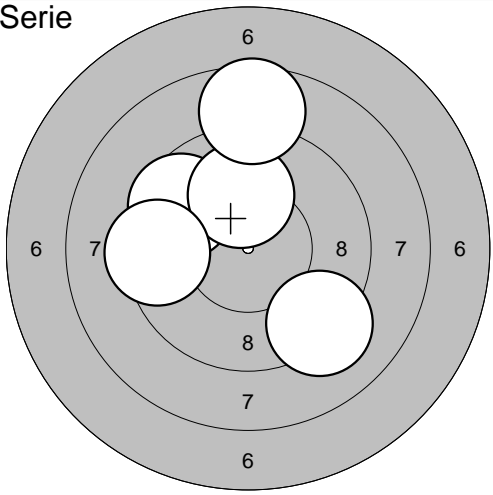

1: 9,2	↘
2: 9,6	↗
3: 10,0	↑
4: 9,4	←
5: 8,6	↑
<b>Serie: 46,8</b>	
<b>Summa: 411,8</b>	

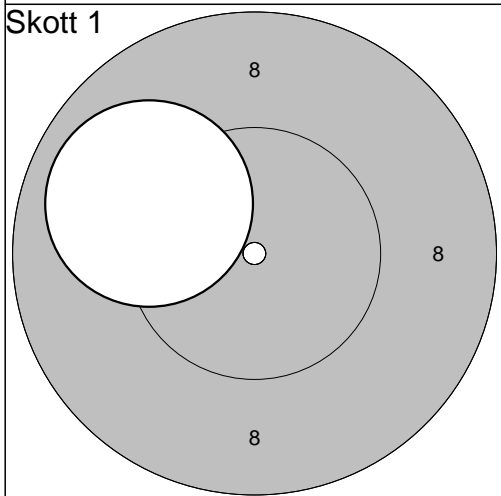

1: 9,9	←
<b>Serie: 9,9</b>	
<b>Summa: 421,7</b>	

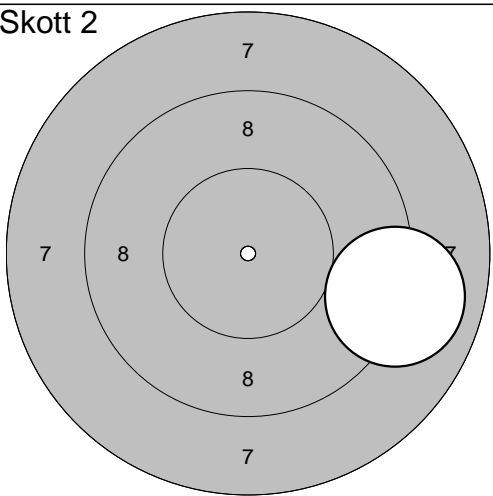

1: 9,0	→
<b>Serie: 9,0</b>	
<b>Summa: 430,7</b>	

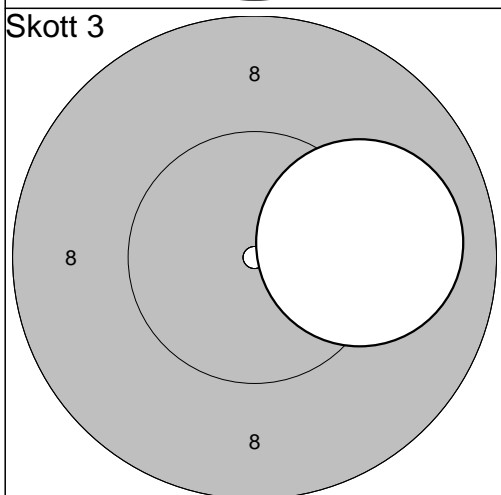

1: 10,0	→
<b>Serie: 10,0</b>	
<b>Summa: 440,7</b>	

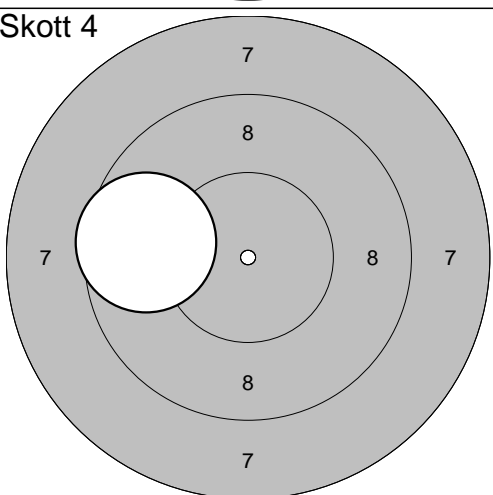

1: 9,6	←
<b>Serie: 9,6</b>	
<b>Summa: 450,3</b>	

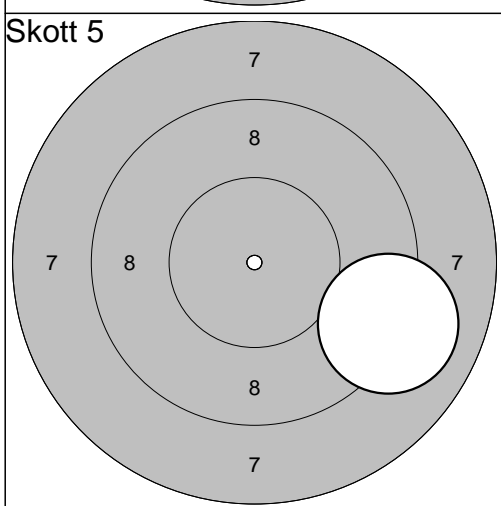

1: 9,1	→
<b>Serie: 9,1</b>	
<b>Summa: 459,4</b>	

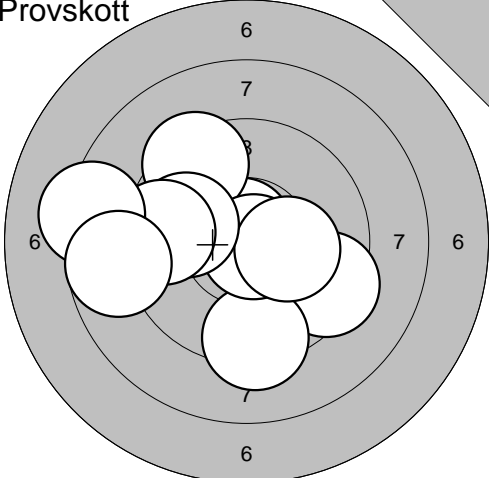
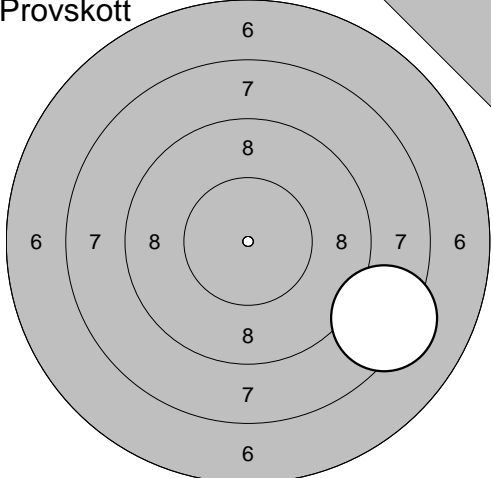
<b>Provskott</b> 	1: 9,4 → 2: 9,3 ↓ 3: 10,7* ↗ 4: 9,4 ↗ 5: 10,8* ↓ 6: 10,2* → 7: 9,9 ↖ 8: 9,5 ← 9: 8,3 ← 10: 8,8 ← <hr/> Serie: 96,3 Summa: 365,0	<b>Provskott</b> 	11: 8,3 → <hr/> Serie: 8,3 Summa: 365,0
--	--	--	---

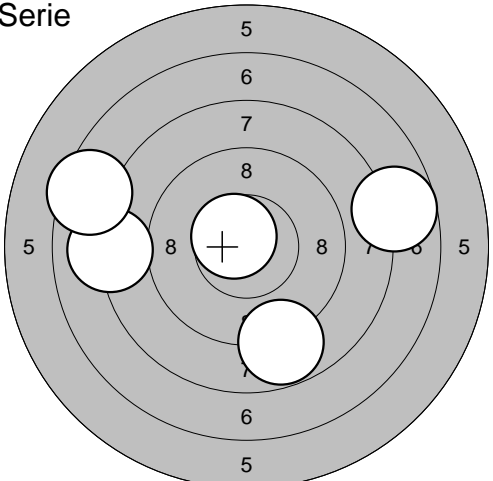
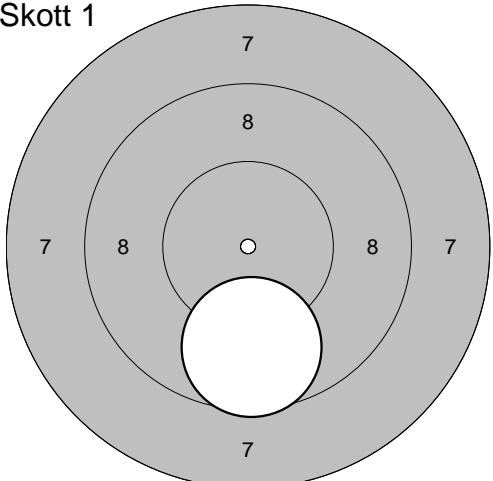
<b>Serie</b> 	1: 8,8 ↓ 2: 7,7 → 3: 8,1 ← 4: 10,6* ↗ 5: 7,5 ← <hr/> Serie: 42,7 Summa: 407,7	<b>Skott 1</b> 	1: 9,7 ↓ <hr/> Serie: 9,7 Summa: 417,4
---	---	---	--

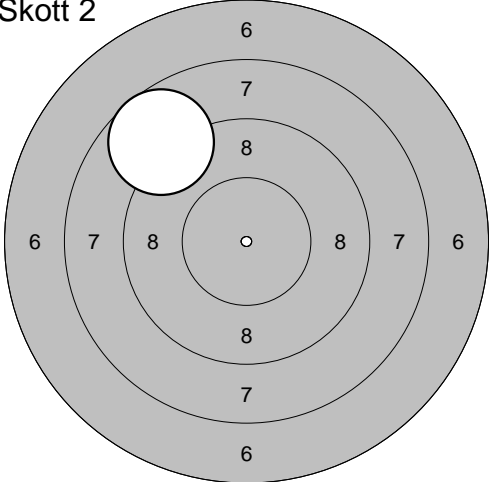
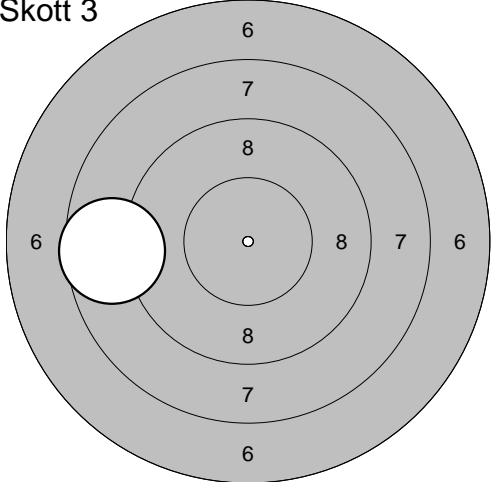
<b>Skott 2</b> 	1: 8,7 ↖ <hr/> Serie: 8,7 Summa: 426,1	<b>Skott 3</b> 	1: 8,6 ← <hr/> Serie: 8,6 Summa: 434,7
--	--	--	--

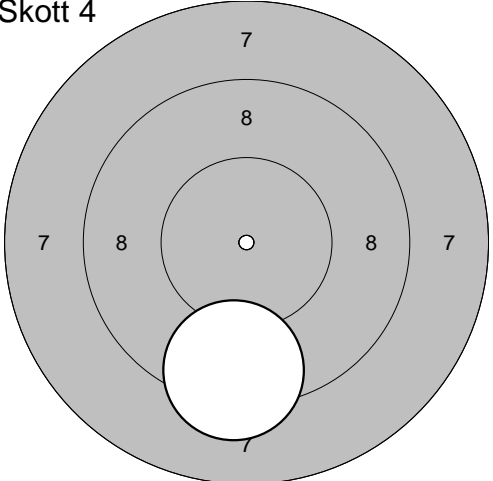
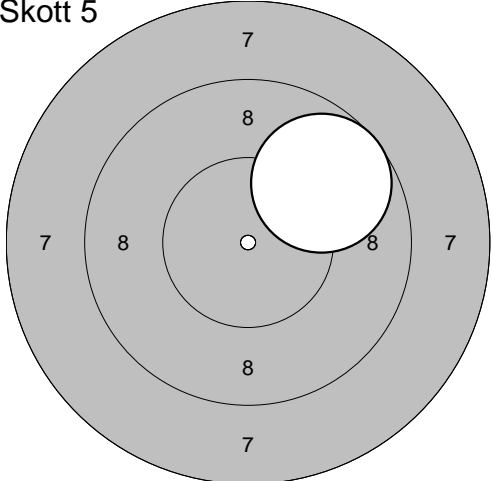
<b>Skott 4</b> 	1: 9,3 ↓ <hr/> Serie: 9,3 Summa: 444,0	<b>Skott 5</b> 	1: 9,7 ↗ <hr/> Serie: 9,7 Summa: 453,7
--	--	--	--

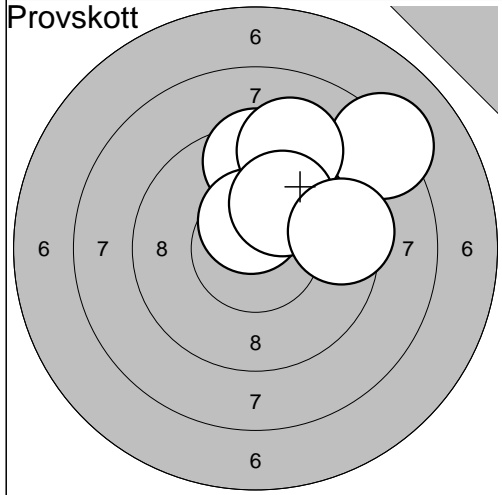

1: 9,5	↑
2: 10,5*	↑
3: 8,2	↗
4: 9,2	↑
5: 10,1	↗
6: 9,5	→
<b>Serie: 57,0</b>	
<b>Summa: 360,0</b>	

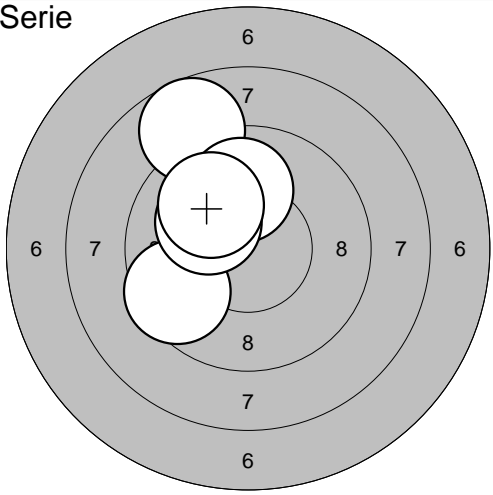

1: 9,6	↙
2: 8,7	↗
3: 10,0	↑
4: 10,1	↗
5: 10,0	↗
<b>Serie: 48,4</b>	
<b>Summa: 408,4</b>	

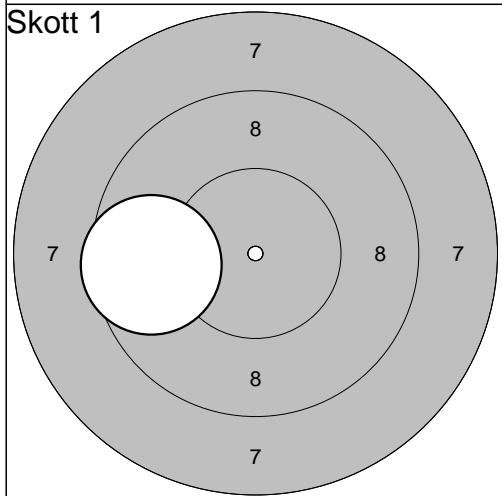

1: 9,6	←
<b>Serie: 9,6</b>	
<b>Summa: 418,0</b>	

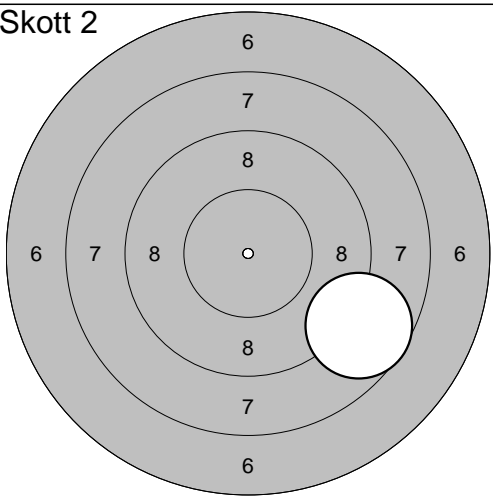

1: 8,7	↘
<b>Serie: 8,7</b>	
<b>Summa: 426,7</b>	

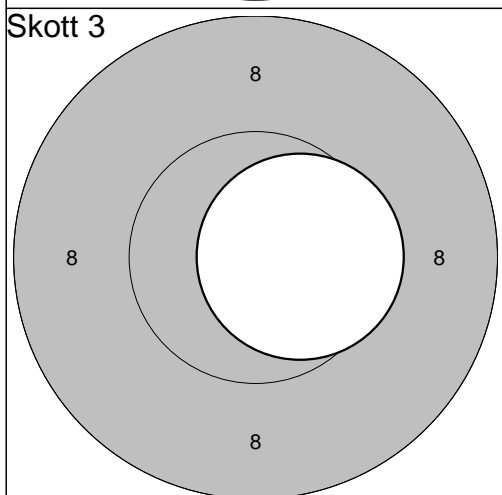

1: 10,6*	→
<b>Serie: 10,6</b>	
<b>Summa: 437,3</b>	

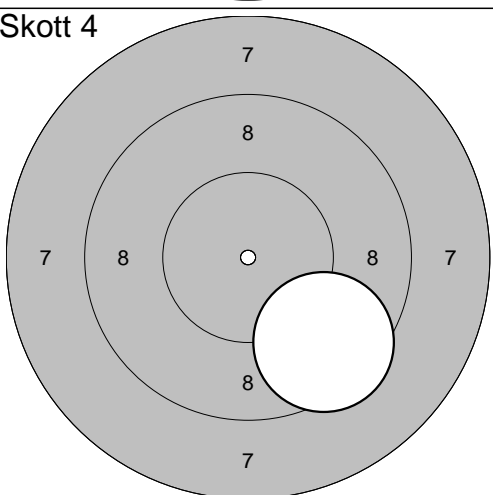

1: 9,5	↘
<b>Serie: 9,5</b>	
<b>Summa: 446,8</b>	

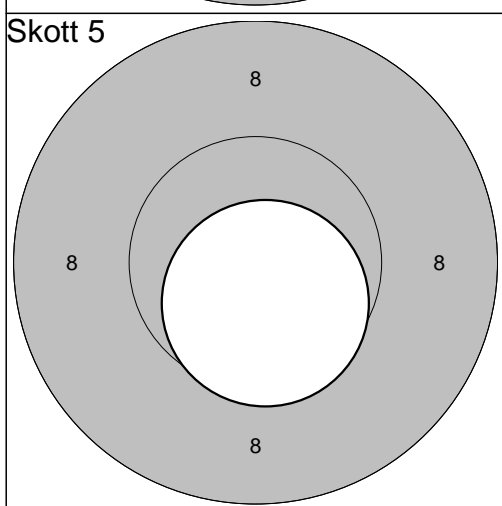

1: 10,6*	↓
<b>Serie: 10,6</b>	
<b>Summa: 457,4</b>	

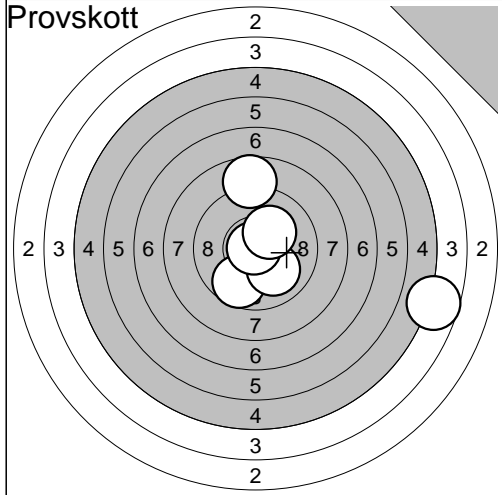

1: 9,7 ↙  
 2: 4,7 →  
 3: 10,0 ↘  
 4: 8,7 ↑  
 5: 10,9\* ←  
 6: 10,2\* ↗

Serie: 54,2  
 Summa: 356,0

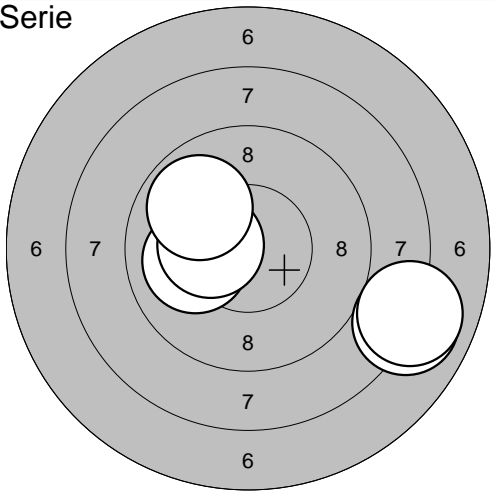

Serie

1: 10,0 ←  
 2: 8,0 →  
 3: 10,3\* ←  
 4: 9,9 ↗  
 5: 8,0 ↘

Serie: 46,2  
 Summa: 402,2

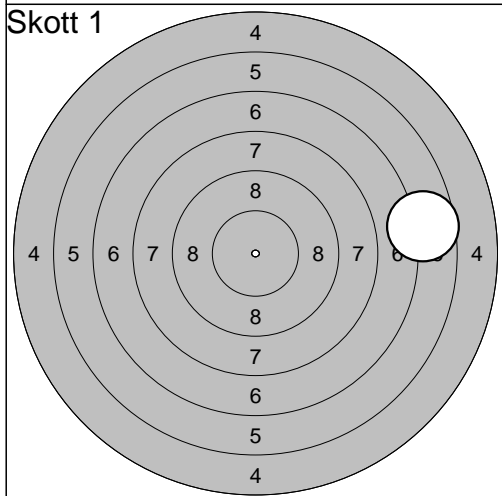

1: 6,7 →

Serie: 6,7  
 Summa: 408,9

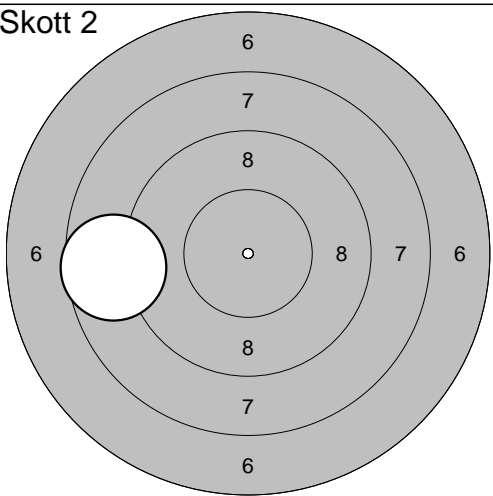

Skott 2

1: 8,7 ←

Serie: 8,7  
 Summa: 417,6

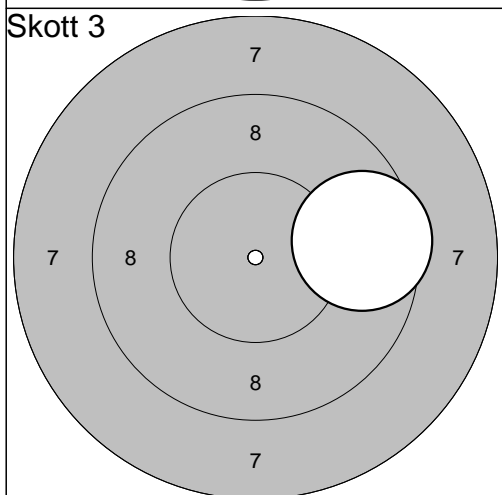

1: 9,6 →

Serie: 9,6  
 Summa: 427,2

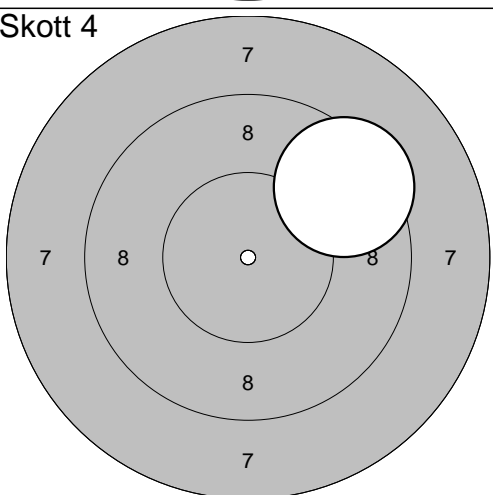

Skott 4

1: 9,4 ↗

Serie: 9,4  
 Summa: 436,6

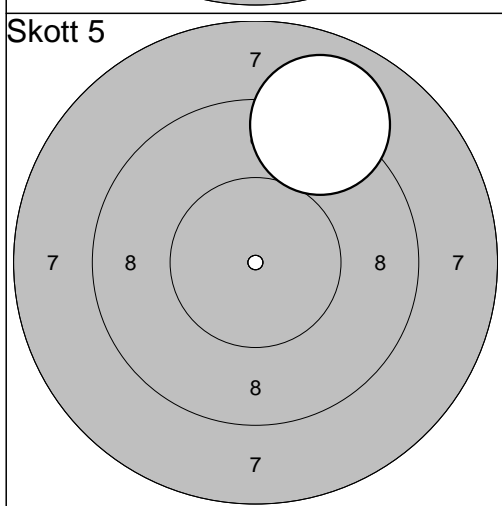

1: 9,0 ↗

Serie: 9,0  
 Summa: 445,6

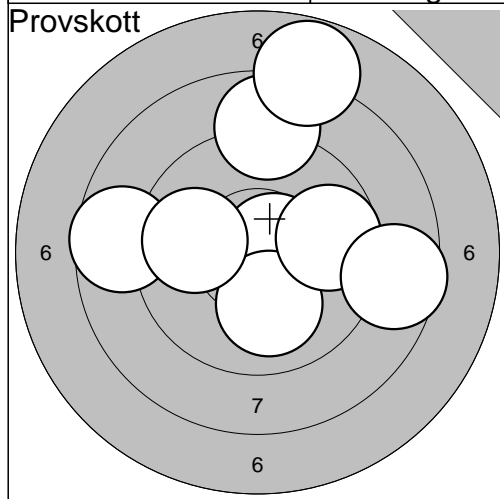

1: 8,8	↑
2: 10,6*	→
3: 7,8	↑
4: 8,7	←
5: 10,1	↓
6: 9,9	←
7: 9,7	→
8: 8,6	→
<hr/>	
Serie:	74,2
Summa:	355,0

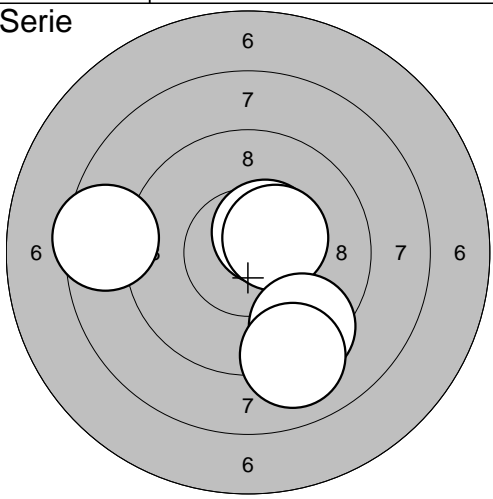

1: 8,5	←
2: 10,5*	↗
3: 10,4*	→
4: 9,4	↘
5: 9,0	↓
<hr/>	
Serie:	47,8
Summa:	402,8

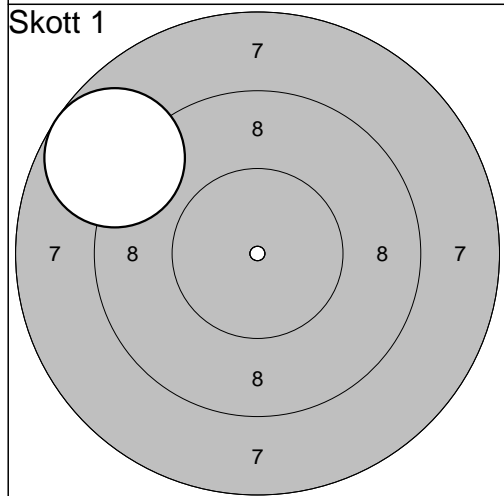

1: 8,8	↖
<hr/>	
Serie:	8,8
Summa:	411,6

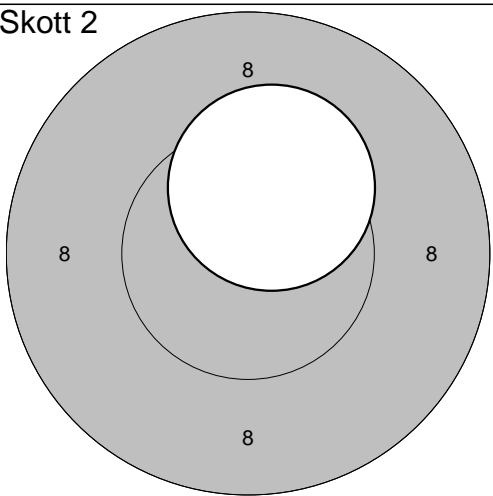

1: 10,3*	↑
<hr/>	
Serie:	10,3
Summa:	421,9

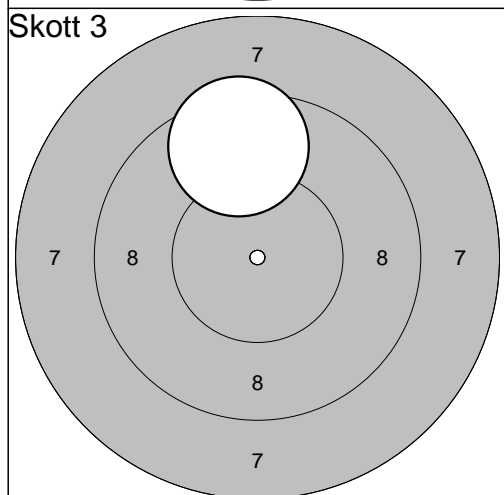

1: 9,5	↑
<hr/>	
Serie:	9,5
Summa:	431,4

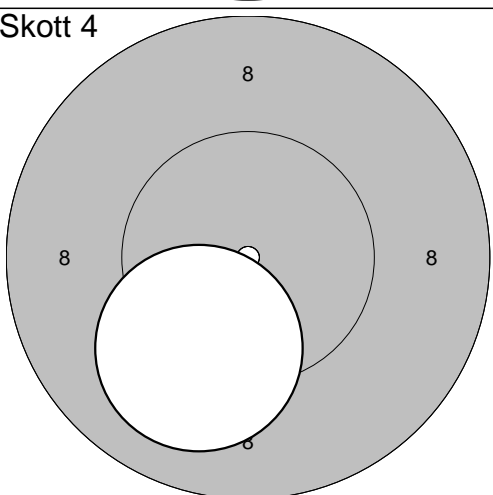

1: 10,1	↘
<hr/>	
Serie:	10,1
Summa:	441,5

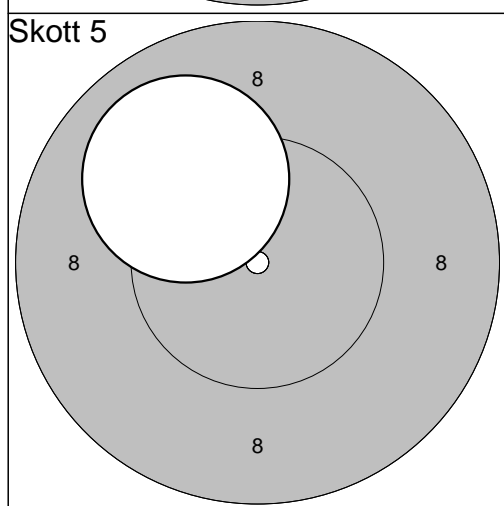

1: 10,0	↖
<hr/>	
Serie:	10,0
Summa:	451,5