

# Provskott

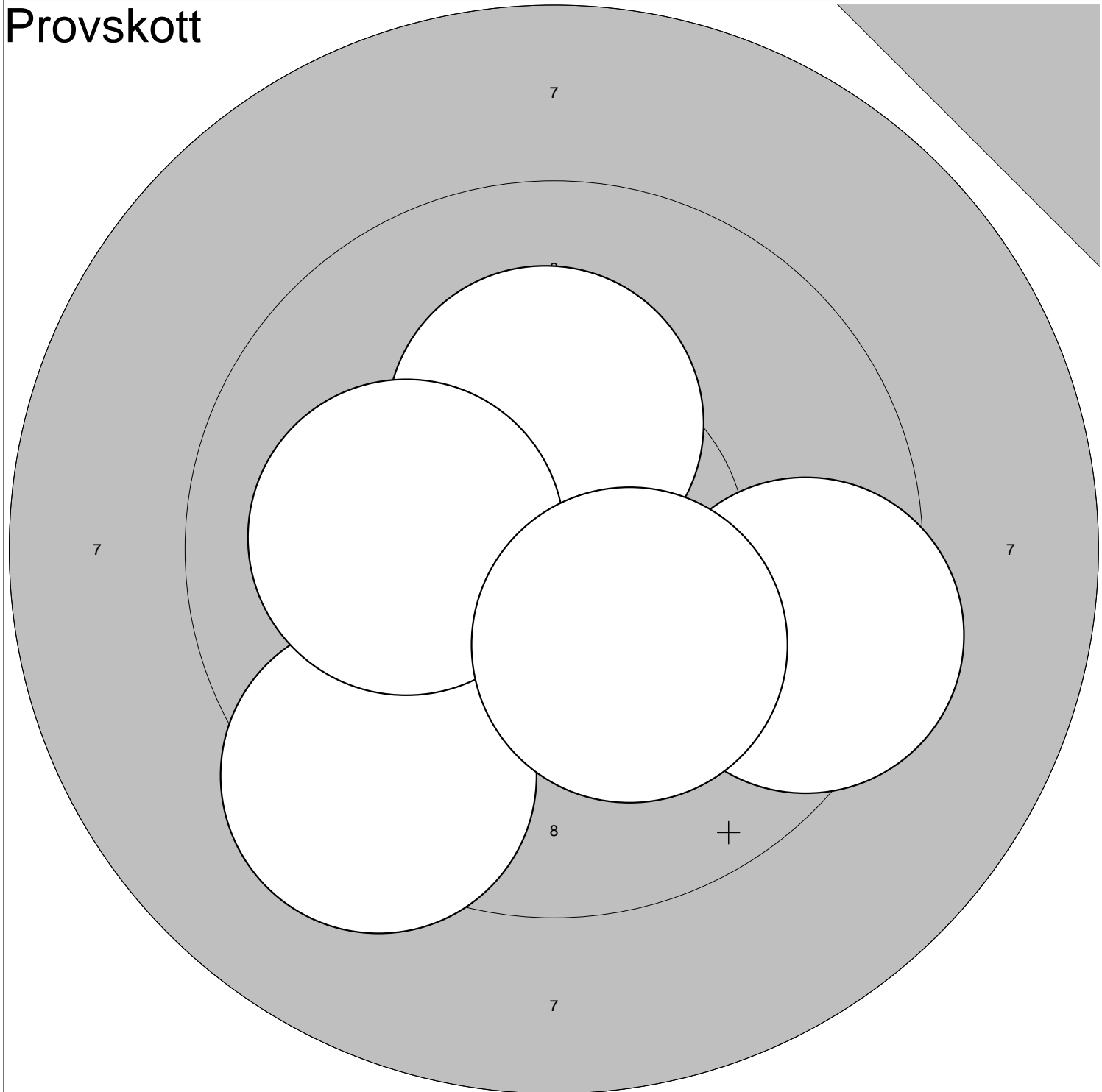

1: 0,0 ↘	6:10,3* ↘	Serie: 48,0
2: 9,3 ↘		
3:10,2* ↑		Summa: 0,0
4:10,1 ←		
5: 9,4 ↘		

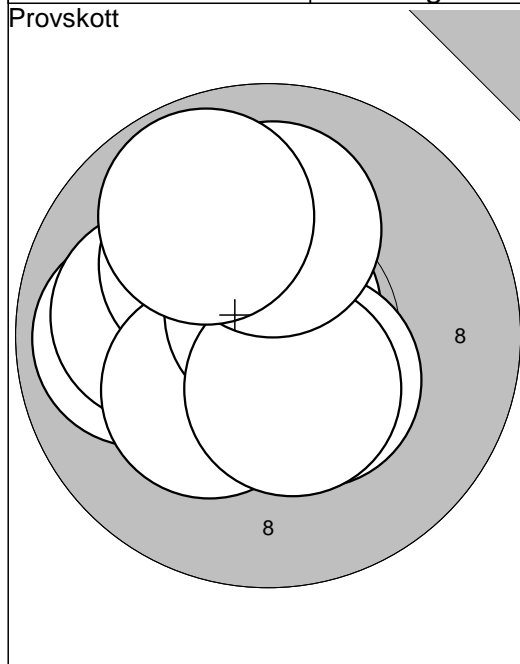

1: 9,9	←
2: 10,0	←
3: 10,2*	↗
4: 10,7*	↑
5: 10,3*	↙
6: 10,7*	↑
7: 10,4*	↘
8: 10,5*	↘
9: 10,1	↑
10: 9,8	↖
Serie: 98,0	
Summa: 0,0	

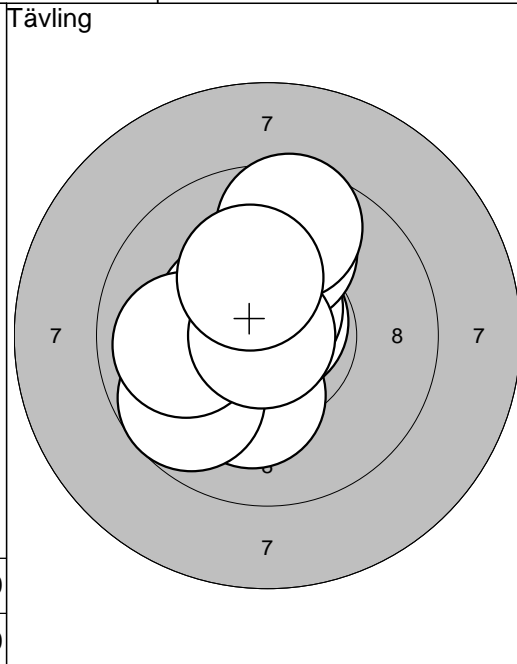

1: 10,2*	↓
2: 9,7	↙
3: 10,4*	↖
4: 10,8*	↗
5: 10,6*	↑
6: 10,0	←
7: 9,9	↑
8: 10,9*	←
9: 9,6	↑
10: 10,2*	↑
Serie: 97,0	
Summa: 97,0	

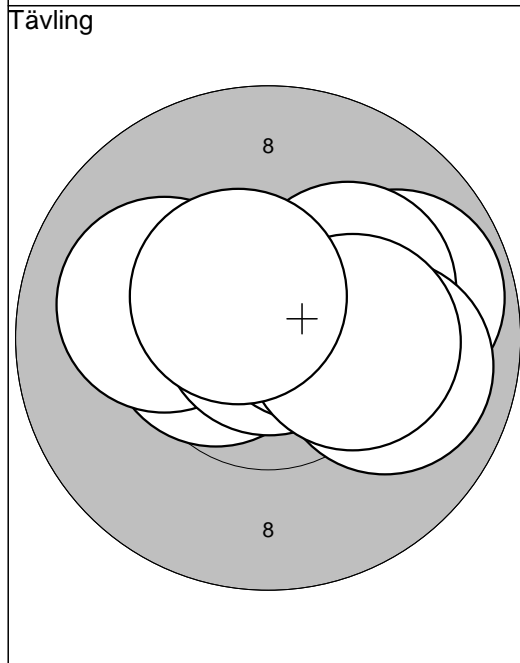

11: 10,5*	←
12: 10,1	←
13: 10,3*	↗
14: 10,9*	↑
15: 9,8	→
16: 10,5*	↗
17: 10,2*	↗
18: 9,9	→
19: 10,2*	→
20: 10,5*	↖
Serie: 98,0	
Summa: 195,0	

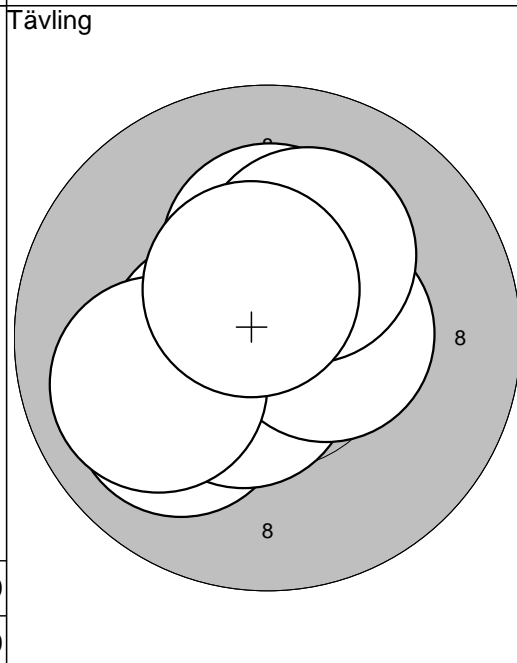

21: 10,6*	↗
22: 10,2*	↑
23: 10,6*	↖
24: 10,5*	←
25: 10,0	↙
26: 10,5*	↘
27: 10,5*	→
28: 10,2*	↗
29: 10,0	←
30: 10,5*	↑
Serie: 100,0	
Summa: 295,0	

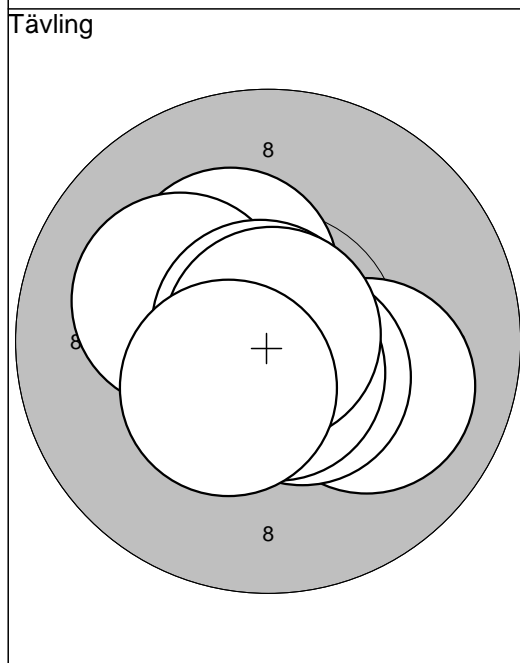

31: 10,3*	↗
32: 10,8*	←
33: 10,2*	↖
34: 10,8*	↗
35: 10,6*	↘
36: 10,0	↘
37: 10,5*	↘
38: 10,7*	↘
39: 10,9*	↗
40: 10,4*	↙
Serie: 100,0	
Summa: 395,0	

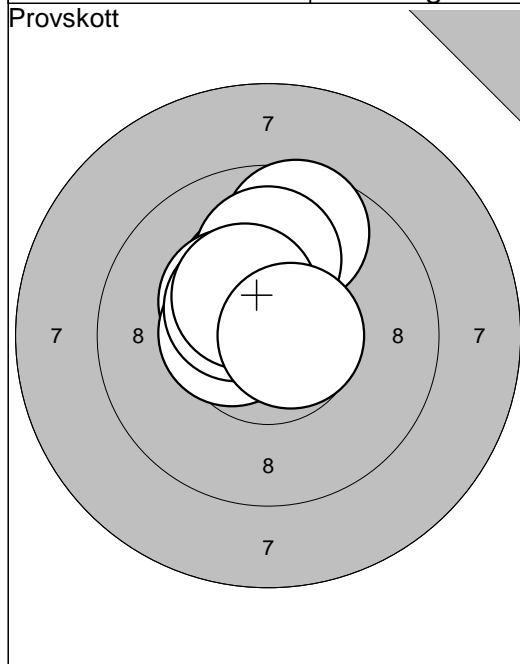

1: 9,6	↗
2: 10,3*	↗
3: 10,0	↑
4: 10,3*	↖
5: 10,5*	←
6: 10,5*	↖
7: 10,4*	↗
8: 10,7*	→
Serie: 79,0	
Summa: 0,0	

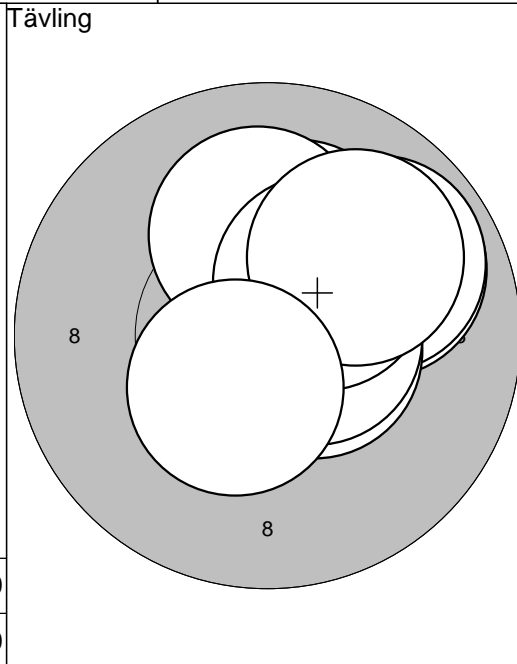

1: 9,9	↗
2: 10,2*	↗
3: 10,3*	↖
4: 9,9	↖
5: 10,5*	→
6: 10,6*	→
7: 10,1	↑
8: 10,3*	↖
9: 10,0	↖
10: 10,4*	↘
Serie: 98,0	
Summa: 98,0	

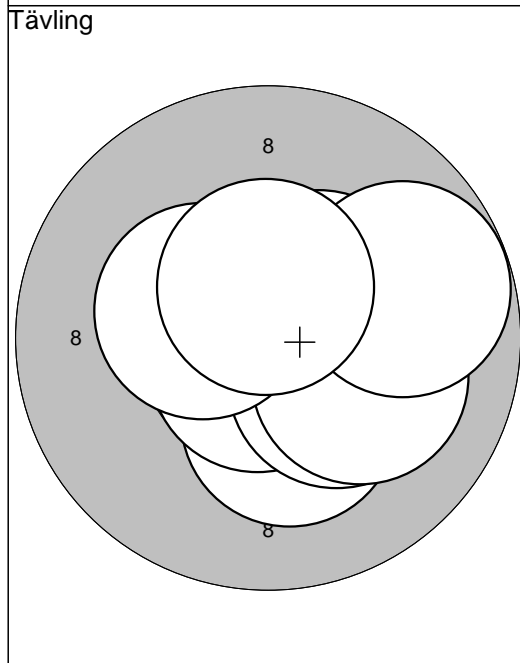

11: 10,4*	↗
12: 10,9*	↓
13: 10,3*	↓
14: 10,7*	→
15: 10,7*	↓
16: 10,3*	↘
17: 10,1	→
18: 10,4*	↖
19: 9,8	→
20: 10,5*	↑
Serie: 99,0	
Summa: 197,0	

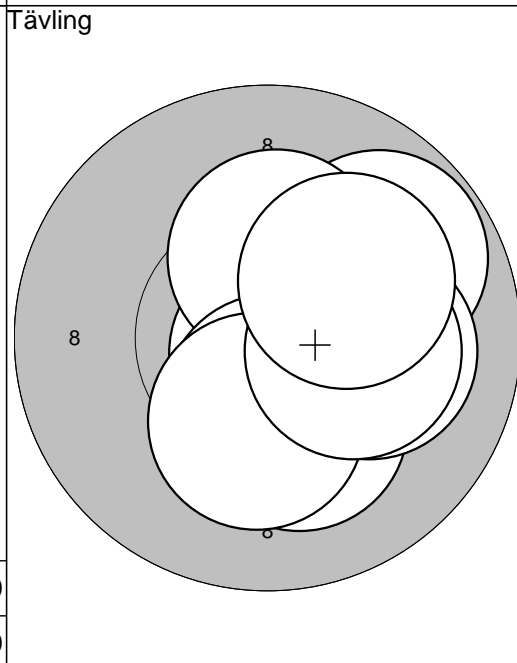

21: 9,8	↗
22: 10,5*	→
23: 10,8*	↘
24: 10,3*	↑
25: 10,4*	↓
26: 10,2*	↓
27: 10,1	→
28: 10,3*	↓
29: 10,2*	→
30: 10,1	↖
Serie: 99,0	
Summa: 296,0	

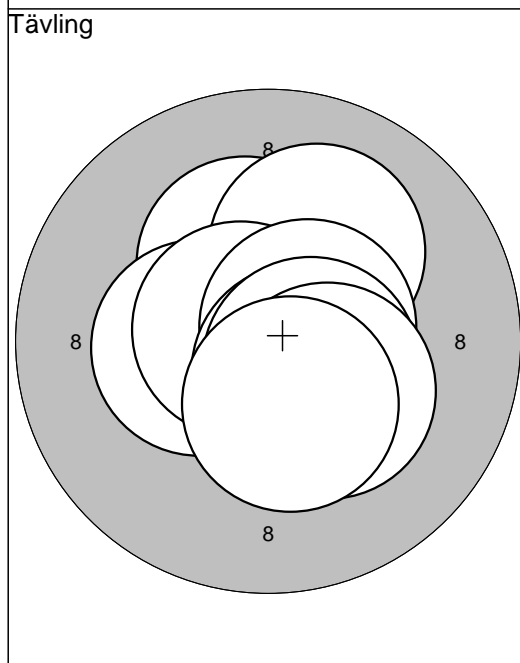

31: 10,5*	↗
32: 10,3*	↗
33: 10,4*	←
34: 10,1	↗
35: 10,7*	↖
36: 10,6*	→
37: 10,6*	↘
38: 10,5*	↘
39: 10,3*	↘
40: 10,4*	↓
Serie: 100,0	
Summa: 396,0	

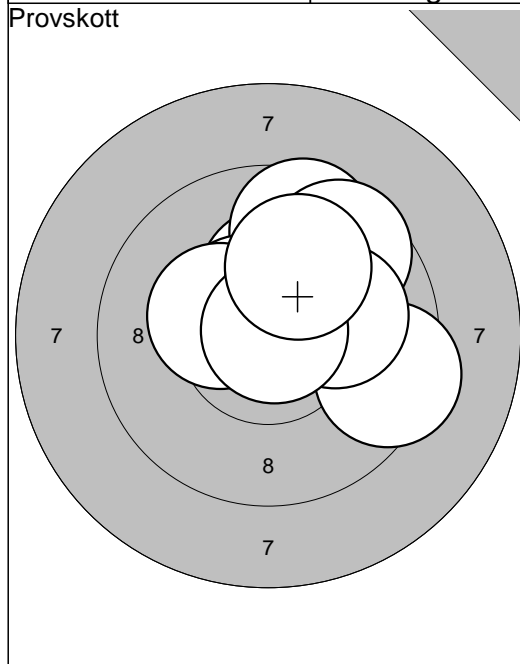

1: 9,4	→
2: 10,3*	↑
3: 9,6	↗
4: 9,6	↘
5: 10,5*	↖
6: 10,3*	↙
7: 10,2*	↗
8: 10,1	→
9: 10,8*	↗
10: 10,0	↗
<b>Serie: 97,0</b>	
<b>Summa: 0,0</b>	

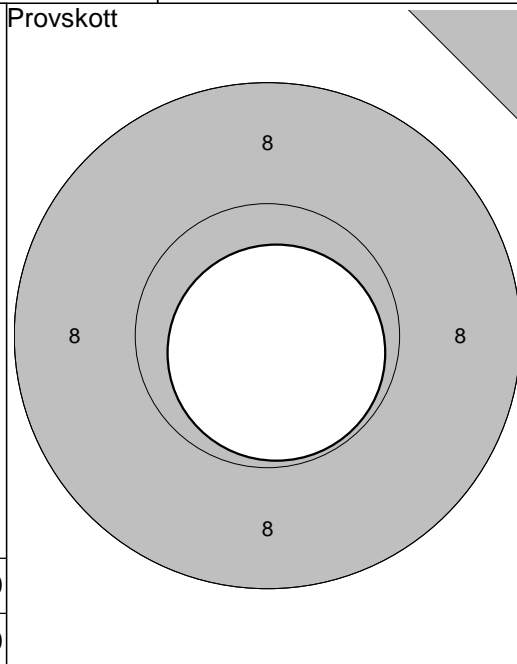

11: 10,8*	↘
<b>Serie: 10,0</b>	
<b>Summa: 0,0</b>	

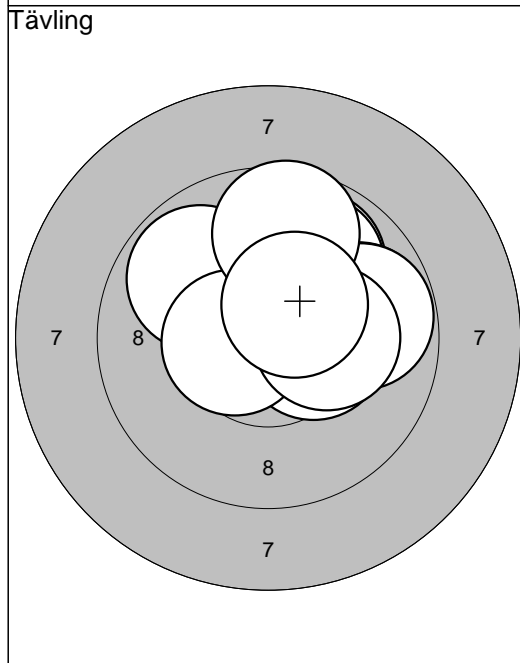

1: 9,9	↗
2: 10,4*	→
3: 9,9	↖
4: 9,9	↗
5: 9,8	→
6: 9,8	→
7: 10,5*	↙
8: 9,7	↑
9: 10,2*	→
10: 10,4*	↗
<b>Serie: 94,0</b>	
<b>Summa: 94,0</b>	

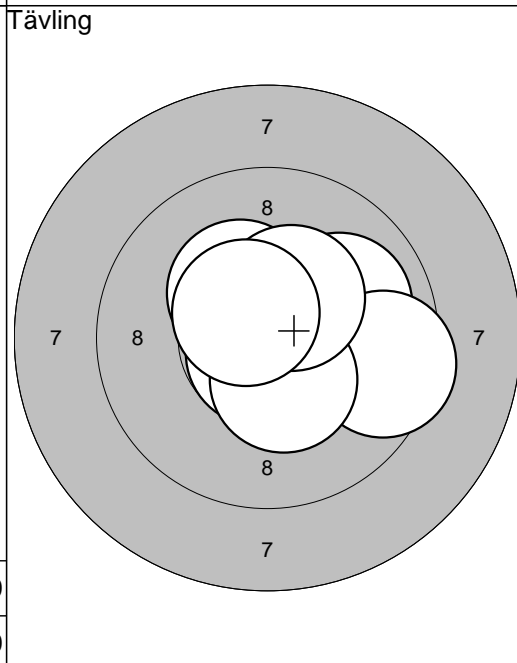

11: 10,6*	→
12: 10,0	↗
13: 10,5*	→
14: 10,5*	↗
15: 10,7*	↘
16: 10,3*	↖
17: 9,5	→
18: 10,4*	↘
19: 10,4*	↗
20: 10,5*	↖
<b>Serie: 99,0</b>	
<b>Summa: 193,0</b>	

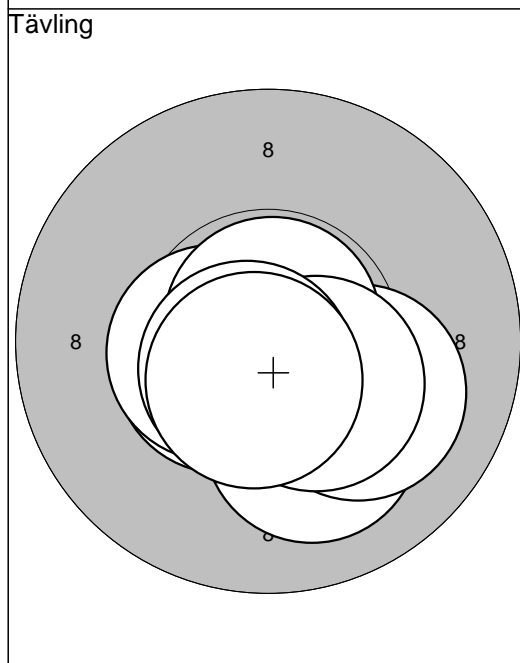

21: 10,1	↘
22: 10,5*	↙
23: 10,5*	↙
24: 10,9*	↘
25: 10,7*	↘
26: 10,1	↘
27: 10,8*	↗
28: 10,4*	↘
29: 10,7*	↘
30: 10,6*	↘
<b>Serie: 100,0</b>	
<b>Summa: 293,0</b>	

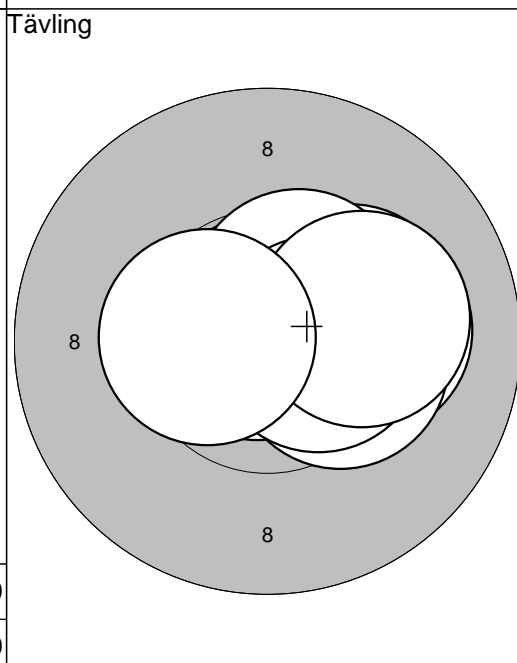

31: 10,8*	↑
32: 10,8*	↖
33: 10,1	→
34: 10,5*	↗
35: 10,2*	→
36: 10,5*	↗
37: 10,3*	→
38: 10,5*	→
39: 10,1	→
40: 10,5*	←
<b>Serie: 100,0</b>	
<b>Summa: 393,0</b>	

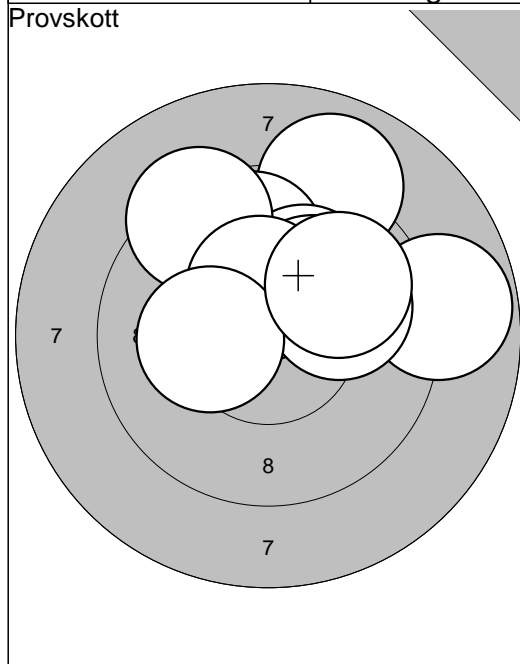

1: 8,8	→
2: 9,0	↗
3: 9,8	↑
4: 10,1	↗
5: 10,2*	↗
6: 9,3	↖
7: 10,4*	↑
8: 10,0	→
9: 10,2*	←
10: 9,9	↗
Serie: 94,0	
Summa: 0,0	

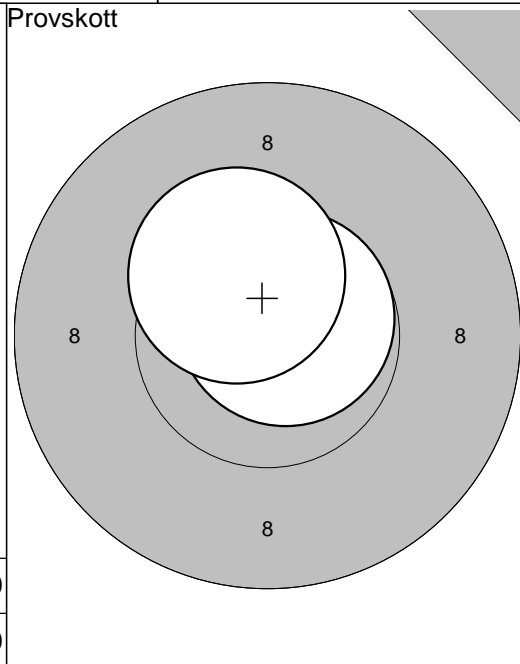

11: 10,7*	↗
12: 10,4*	↖
Serie: 20,0	
Summa: 0,0	

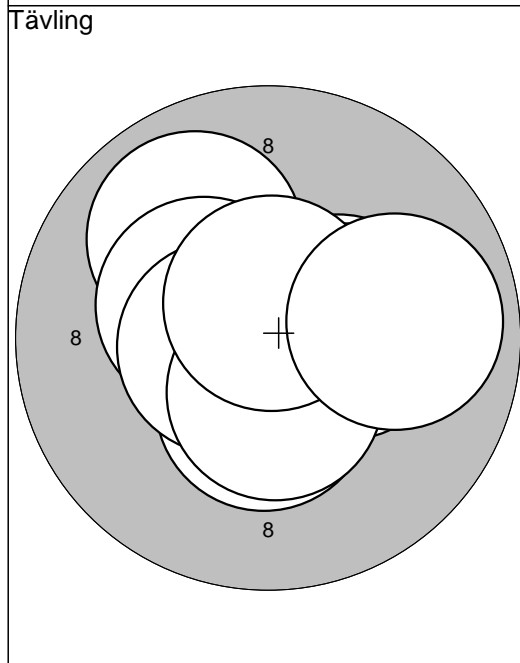

1: 10,8*	↓
2: 9,9	↗
3: 10,4*	↖
4: 10,4*	↓
5: 10,4*	→
6: 10,6*	←
7: 10,3*	→
8: 10,5*	↓
9: 10,7*	↑
10: 9,9	→
Serie: 98,0	
Summa: 98,0	

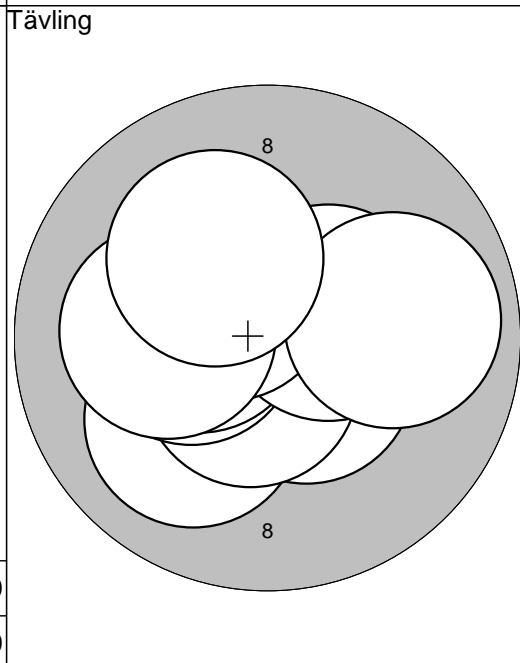

11: 10,5*	↘
12: 10,0	↙
13: 10,6*	↘
14: 10,3*	←
15: 10,4*	←
16: 10,4*	→
17: 10,5*	↗
18: 10,1	←
19: 9,9	→
20: 10,2*	↖
Serie: 99,0	
Summa: 197,0	

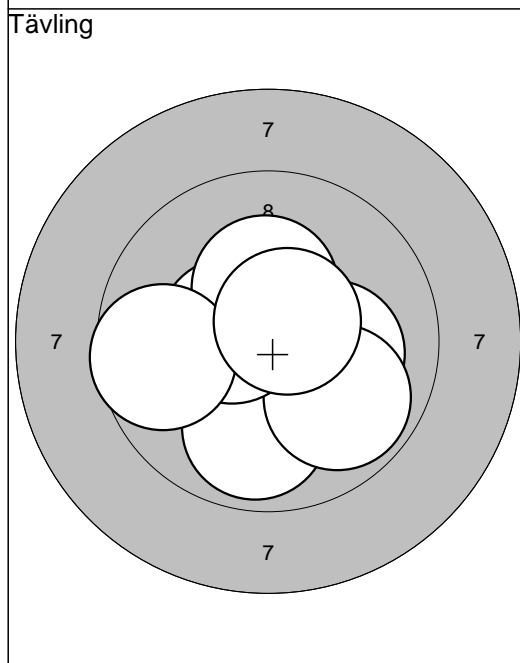

21: 10,6*	→
22: 10,6*	↘
23: 10,1	→
24: 10,5*	↓
25: 9,9	↓
26: 9,9	↘
27: 10,5*	←
28: 10,3*	↑
29: 9,7	←
30: 10,6*	↗
Serie: 97,0	
Summa: 294,0	

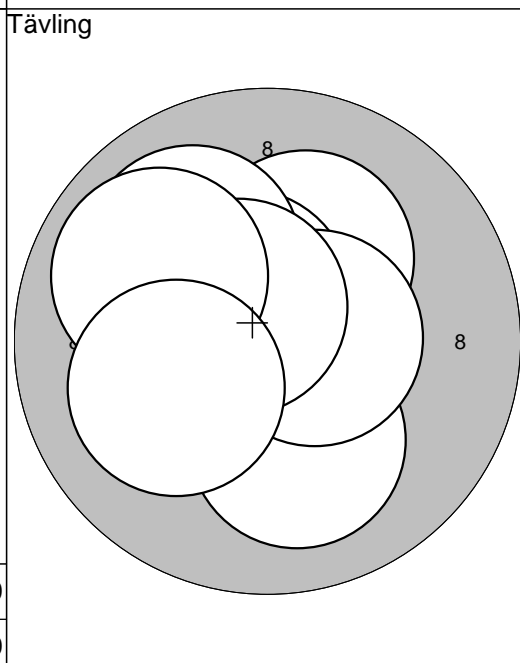

31: 10,7*	→
32: 10,7*	↗
33: 10,2*	↗
34: 10,5*	↗
35: 10,1	↓
36: 10,6*	→
37: 10,0	↗
38: 10,6*	↗
39: 9,9	↖
40: 10,1	↙
Serie: 99,0	
Summa: 393,0	

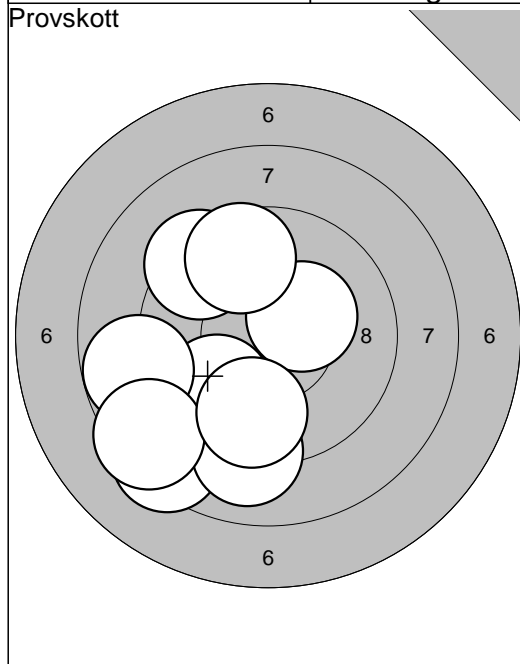

1: 8,4	↙
2: 10,3*	↗
3: 9,4	↖
4: 9,6	↗
5: 9,0	↓
6: 8,8	↙
7: 9,8	↙
8: 8,8	←
9: 8,4	↙
10: 9,7	↓
<b>Serie: 87,0</b>	
<b>Summa: 0,0</b>	

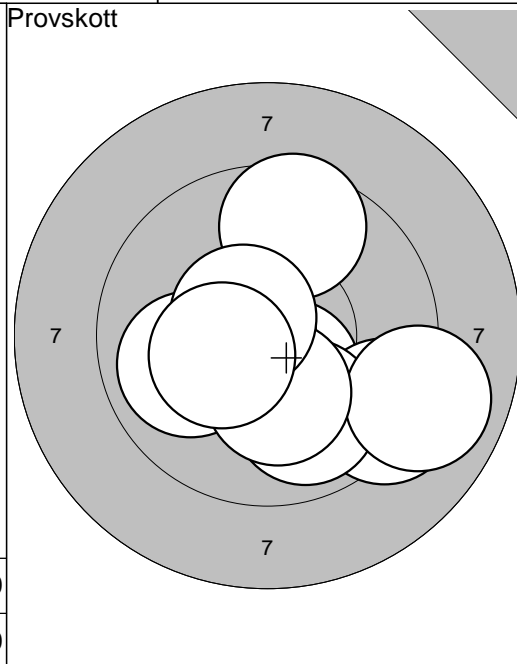

11: 9,9	↙
12: 10,4*	↘
13: 9,2	↘
14: 9,9	↘
15: 8,9	→
16: 9,6	↑
17: 10,6*	↙
18: 10,2*	↓
19: 10,6*	↖
20: 10,3*	↙
<b>Serie: 94,0</b>	
<b>Summa: 0,0</b>	

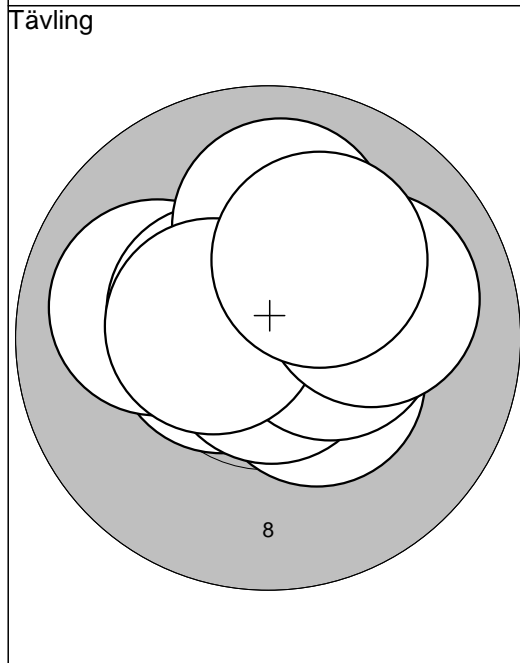

1: 10,6*	←
2: 10,4*	↘
3: 10,8*	↓
4: 10,0	←
5: 10,5*	↖
6: 10,4*	→
7: 10,0	↑
8: 10,5*	←
9: 10,0	→
10: 10,2*	↗
<b>Serie: 100,0</b>	
<b>Summa: 100,0</b>	

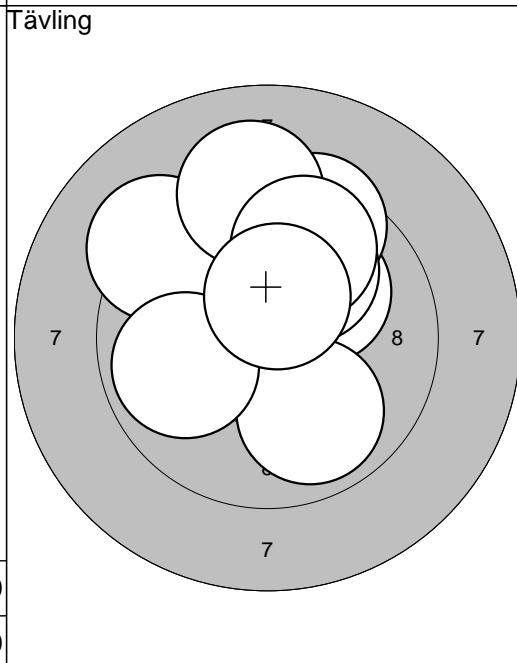

11: 10,3*	↖
12: 10,1	↗
13: 9,2	↖
14: 9,5	↗
15: 9,2	↑
16: 10,0	↗
17: 9,9	↘
18: 9,9	←
19: 9,8	↗
20: 10,4*	↗
<b>Serie: 94,0</b>	
<b>Summa: 194,0</b>	

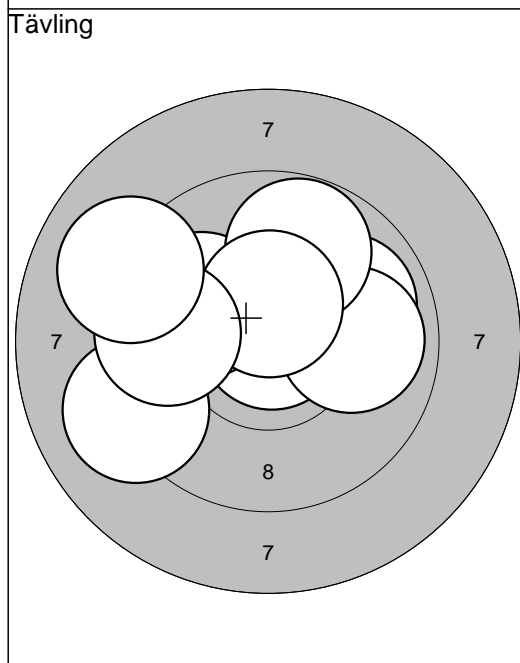

21: 9,1	↙
22: 10,5*	↗
23: 10,9*	↗
24: 9,9	↗
25: 9,9	→
26: 10,0	↖
27: 9,8	↗
28: 10,5*	↑
29: 9,7	←
30: 9,1	↖
<b>Serie: 94,0</b>	
<b>Summa: 288,0</b>	

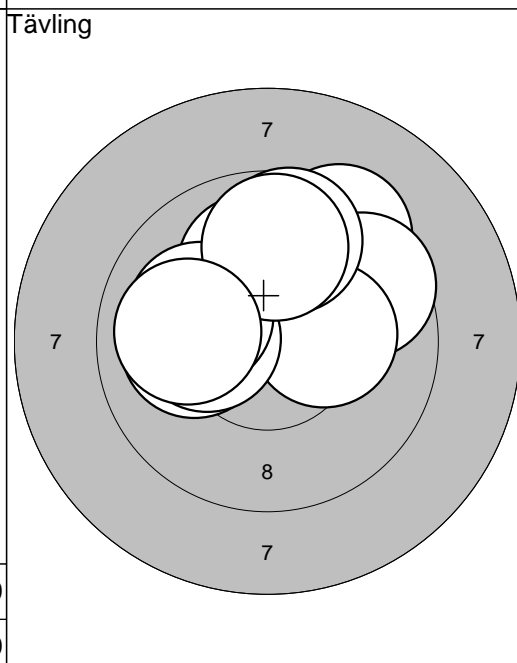

31: 10,0	↑
32: 9,4	↗
33: 9,6	↗
34: 10,1	←
35: 10,3*	→
36: 10,2*	←
37: 10,1	↖
38: 9,7	↑
39: 9,8	↑
40: 10,0	←
<b>Serie: 96,0</b>	
<b>Summa: 384,0</b>	

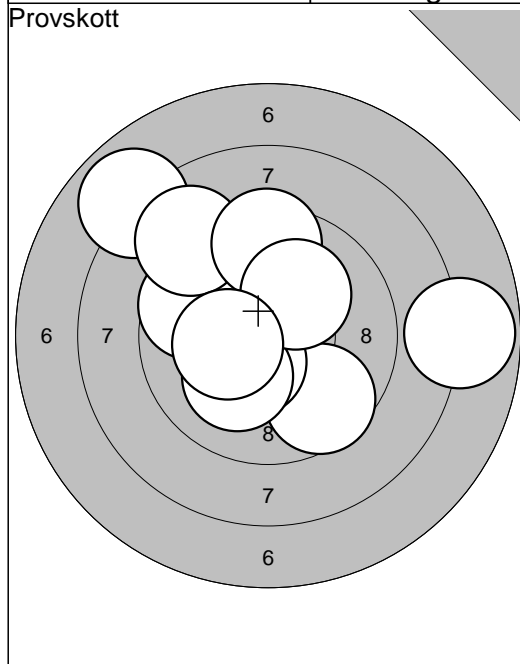

1: 7,9 ↖
2: 9,7 ↖
3: 9,6 ↘
4: 9,0 ↗
5: 9,5 ↑
6: 10,4* ↘
7: 7,8 →
8: 10,1 ↘
9: 10,1 ↗
10: 10,3* ←
Serie: 90,0
Summa: 0,0

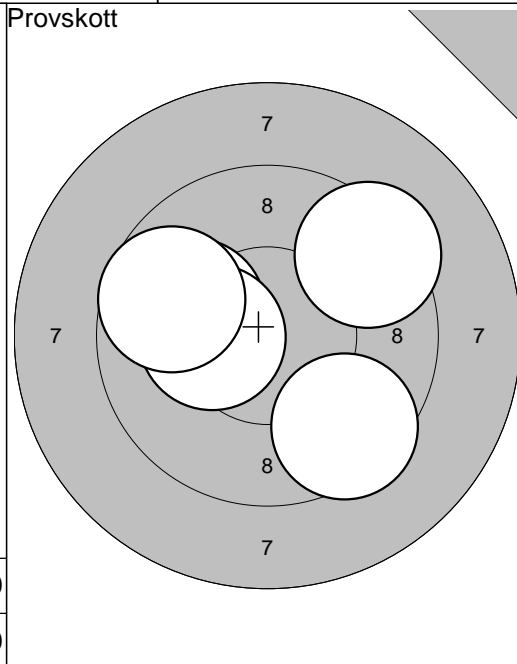

11: 10,0 ←
12: 9,5 ↘
13: 9,4 ↗
14: 10,3* ←
15: 9,7 ←
Serie: 47,0
Summa: 0,0

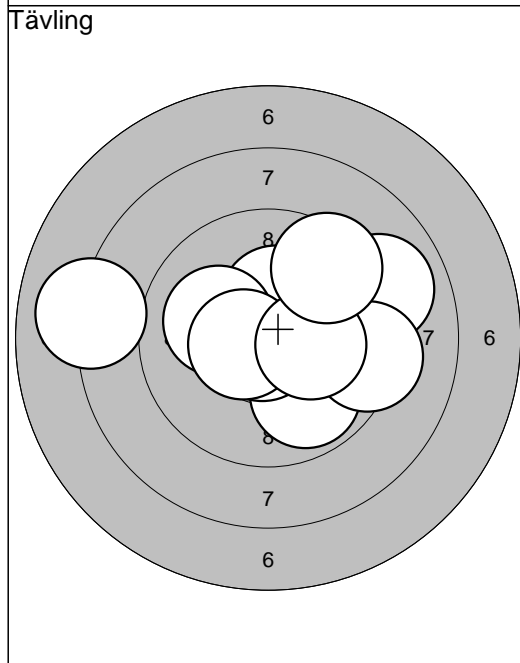

1: 9,9 ↘
2: 10,8* ↘
3: 10,3* ↑
4: 10,1 ←
5: 9,0 →
6: 8,1 ←
7: 10,5* ←
8: 9,3 →
9: 10,2* →
10: 9,5 ↗
Serie: 94,0
Summa: 94,0

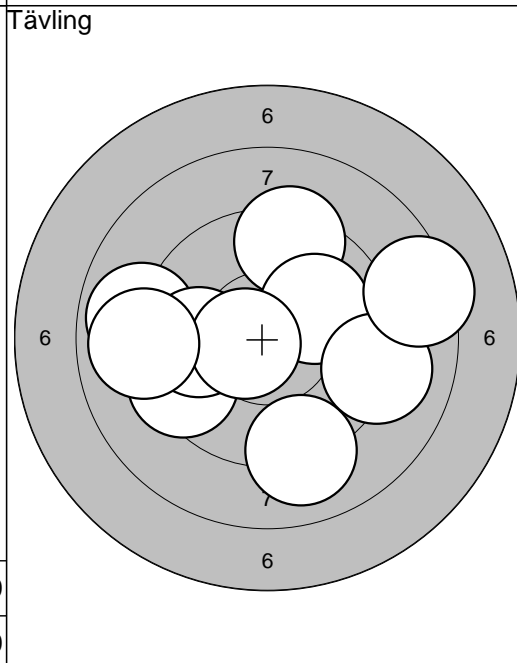

11: 9,4 ↑
12: 9,0 ↘
13: 10,0 ↗
14: 9,4 ←
15: 8,9 ←
16: 9,1 →
17: 8,4 →
18: 9,8 ←
19: 10,6* ←
20: 9,0 ←
Serie: 90,0
Summa: 184,0

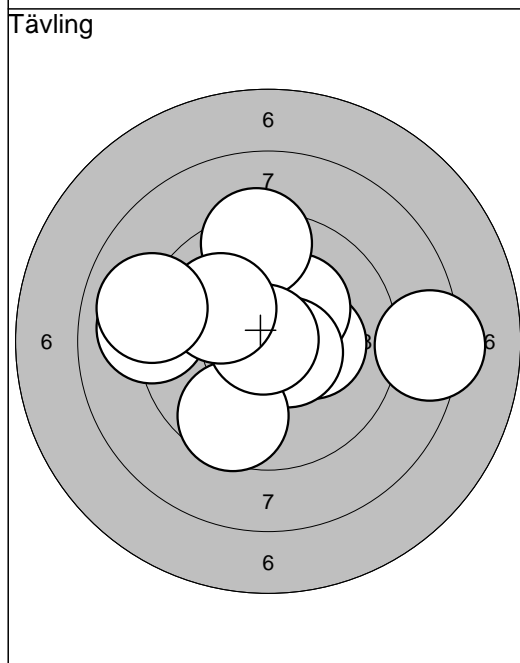

21: 10,2* →
22: 10,3* ↗
23: 8,3 →
24: 10,6* ↘
25: 9,1 ←
26: 9,6 ↘
27: 9,4 ↑
28: 10,9* ←
29: 10,0 ↖
30: 9,0 ←
Serie: 94,0
Summa: 278,0

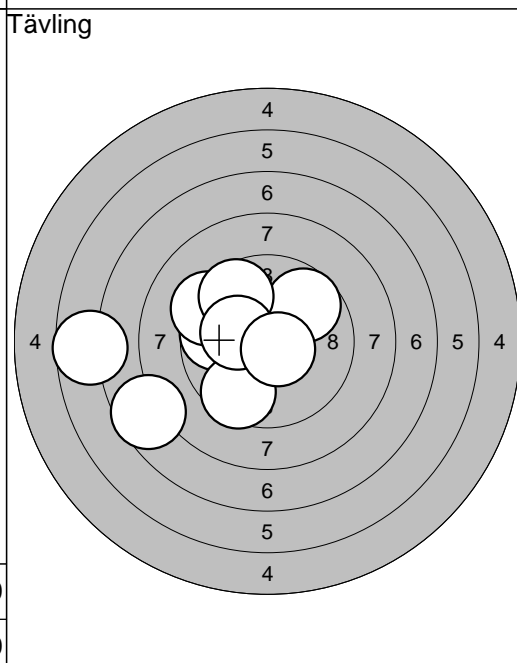

31: 9,7 ←
32: 9,7 ↗
33: 7,6 ←
34: 9,8 ↖
35: 9,5 ↘
36: 9,3 ↖
37: 6,7 ←
38: 9,6 ↗
39: 10,2* ←
40: 10,6* ↘
Serie: 87,0
Summa: 365,0

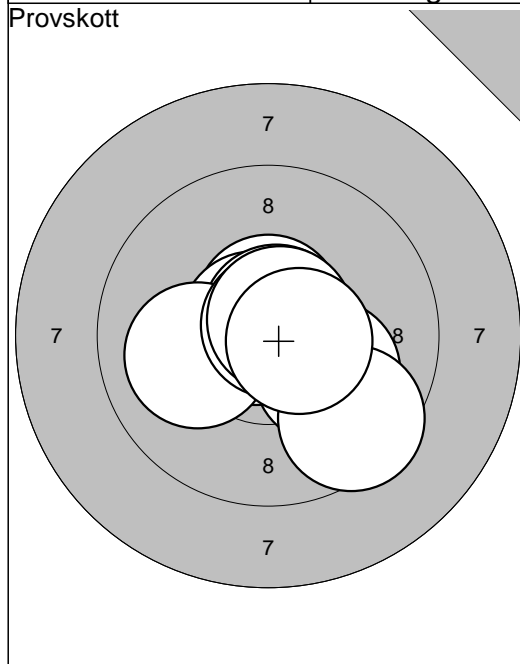

1: 10,1	↘
2: 10,8*	←
3: 10,6*	↑
4: 9,5	↘
5: 10,7*	↖
6: 10,7*	↗
7: 10,1	←
8: 10,8*	↗
9: 10,7*	↗
10: 10,6*	→
Serie: 99,0	
Summa: 0,0	

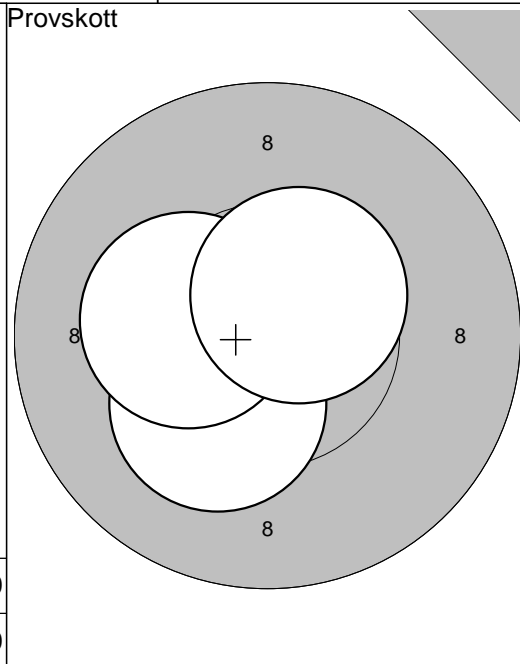

11: 10,3*	↘
12: 10,3*	←
13: 10,5*	↗
Serie: 30,0	
Summa: 0,0	

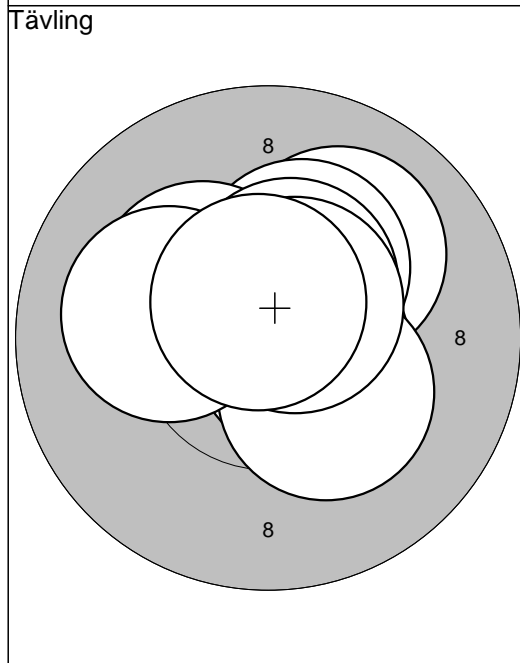

1: 10,0	↗
2: 10,3*	↗
3: 10,6*	→
4: 10,7*	↑
5: 10,3*	↘
6: 10,3*	↖
7: 10,1	←
8: 10,5*	↗
9: 10,6*	↗
10: 10,6*	↑
Serie: 100,0	
Summa: 100,0	

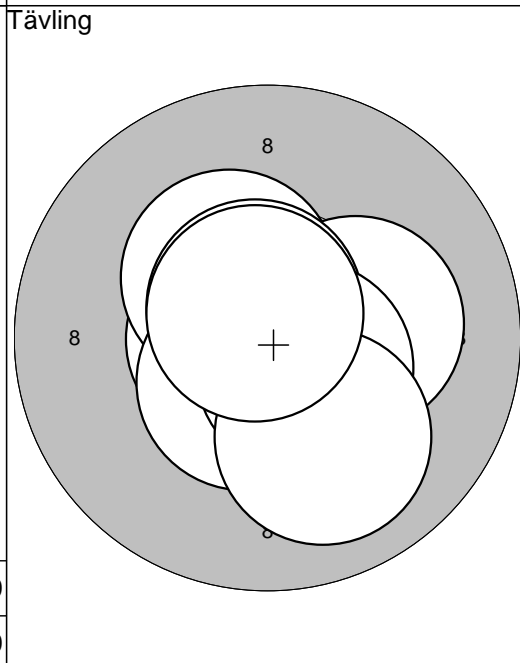

11: 10,7*	←
12: 10,7*	←
13: 10,4*	↗
14: 10,6*	↘
15: 10,2*	→
16: 10,5*	↘
17: 10,7*	↗
18: 10,6*	↘
19: 10,0	↘
20: 10,7*	↗
Serie: 100,0	
Summa: 200,0	

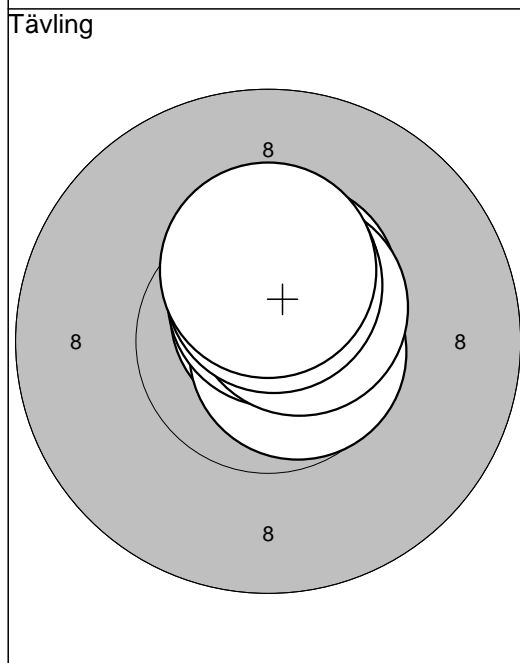

21: 10,5*	↗
22: 10,7*	↗
23: 10,6*	↗
24: 10,7*	→
25: 10,6*	↑
26: 10,5*	↗
27: 10,6*	↗
28: 10,4*	↑
29: 10,5*	↑
30: 10,4*	↑
Serie: 100,0	
Summa: 300,0	

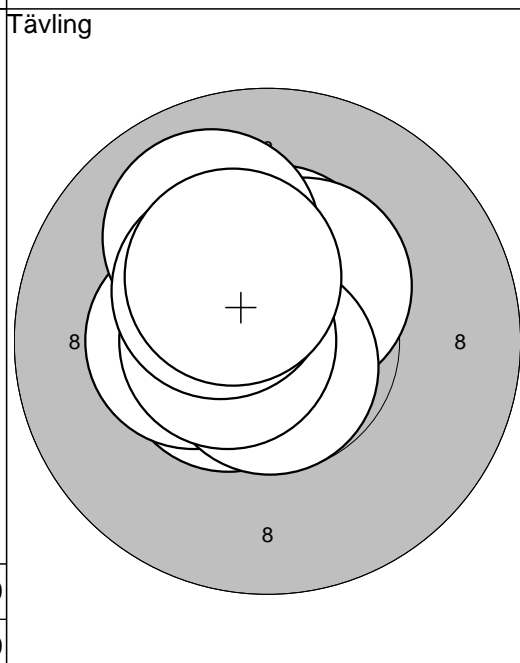

31: 10,5*	↖
32: 10,6*	↙
33: 10,4*	↑
34: 10,3*	←
35: 10,4*	↗
36: 10,7*	↘
37: 10,6*	←
38: 10,0	↗
39: 10,4*	↗
40: 10,3*	↗
Serie: 100,0	
Summa: 400,0	



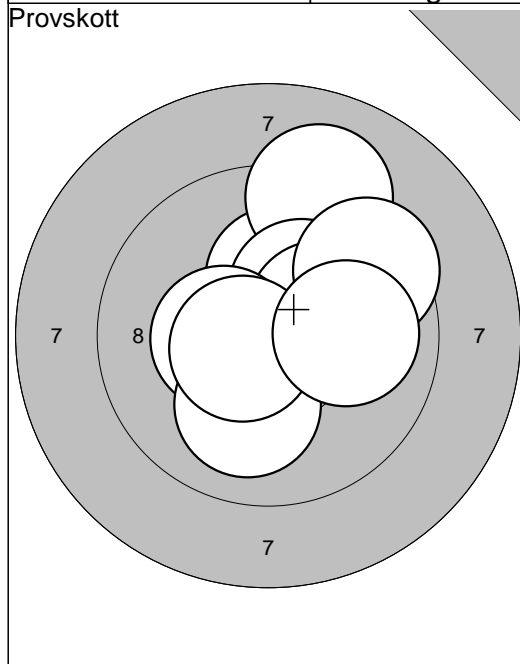

1: 10,2*	↑
2: 9,1	↑
3: 10,3*	↗
4: 10,3*	→
5: 10,4*	←
6: 10,1	↓
7: 10,6*	↙
8: 9,5	↗
9: 10,0	→
<b>Serie: 88,0</b>	
<b>Summa: 0,0</b>	

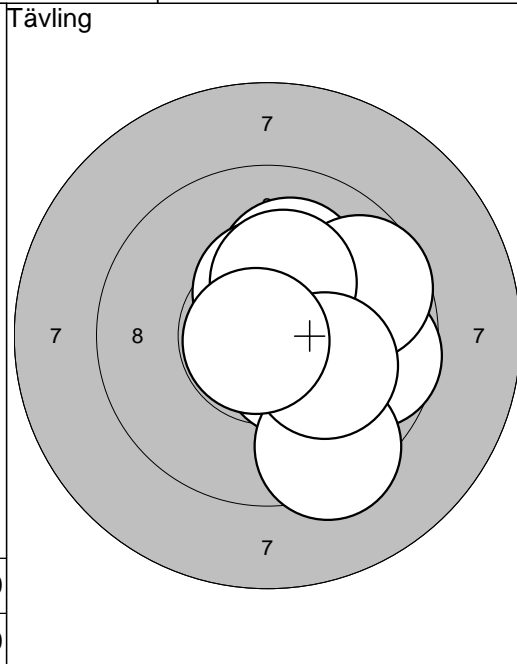

1: 9,7	→
2: 10,5*	↘
3: 10,2*	→
4: 10,1	↑
5: 10,4*	↑
6: 9,7	↗
7: 10,3*	↑
8: 9,4	↓
9: 10,2*	↘
10: 10,8*	↙
<b>Serie: 97,0</b>	
<b>Summa: 97,0</b>	

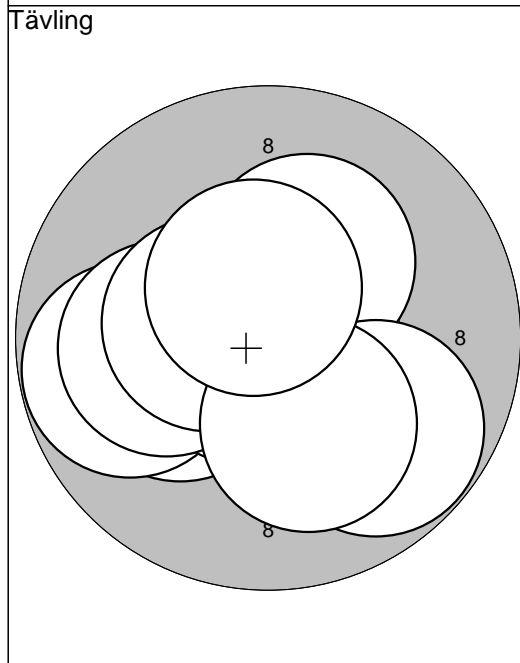

11: 10,2*	←
12: 10,7*	↑
13: 9,8	←
14: 10,7*	↘
15: 10,1	←
16: 10,2*	↑
17: 9,8	↘
18: 10,5*	←
19: 10,2*	↓
20: 10,5*	↑
<b>Serie: 98,0</b>	
<b>Summa: 195,0</b>	

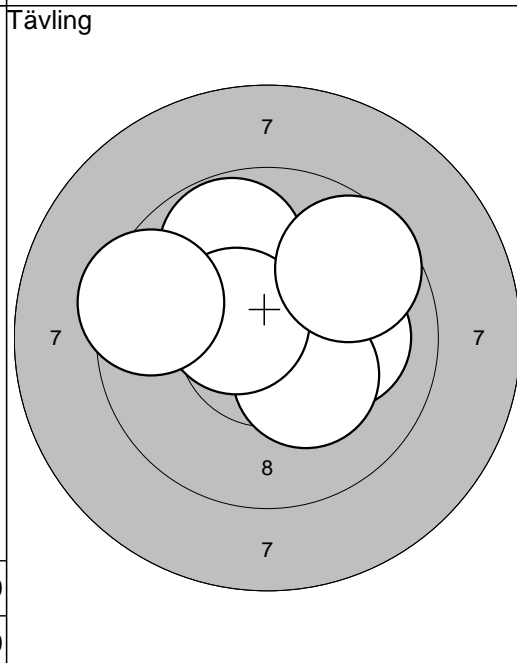

21: 10,2*	↑
22: 10,3*	↙
23: 10,2*	↑
24: 10,4*	↘
25: 10,1	→
26: 9,8	↑
27: 10,3*	↘
28: 10,5*	↙
29: 9,5	←
30: 9,6	↗
<b>Serie: 97,0</b>	
<b>Summa: 292,0</b>	

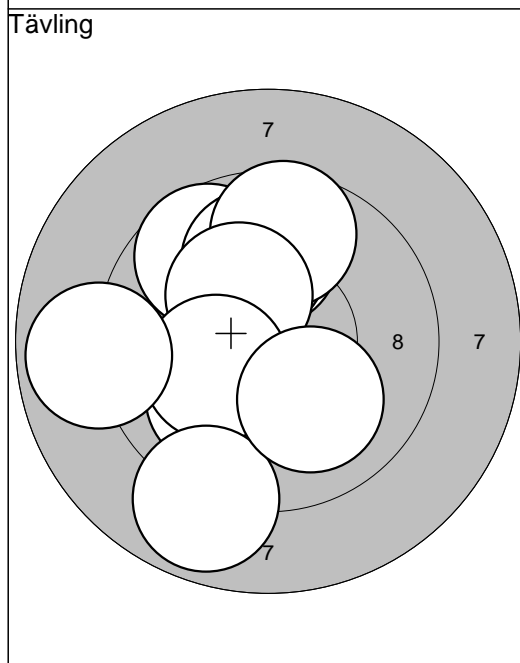

31: 9,7	↖
32: 9,9	↑
33: 10,0	↑
34: 9,6	↑
35: 10,3*	↖
36: 10,0	↘
37: 10,2*	↙
38: 8,9	↓
39: 8,9	←
40: 10,1	↘
<b>Serie: 93,0</b>	
<b>Summa: 385,0</b>	

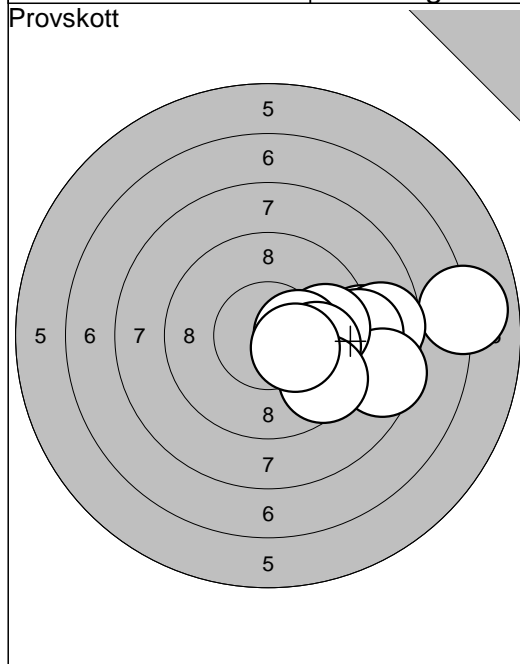

1: 7,0	→
2: 9,1	→
3: 8,7	→
4: 9,1	→
5: 8,5	→
6: 9,8	→
7: 10,3*	→
8: 9,9	→
9: 9,5	↘
10: 10,3*	↘
<b>Serie:</b>	<b>88,0</b>
<b>Summa:</b>	<b>0,0</b>

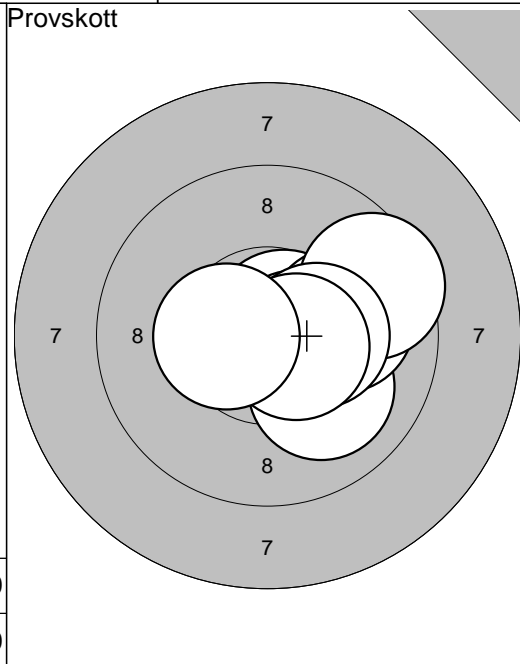

11: 10,0	↘
12: 10,7*	↗
13: 10,0	→
14: 10,6*	↘
15: 9,5	↗
16: 10,3*	→
17: 10,6*	↘
18: 10,5*	←
<b>Serie:</b>	<b>79,0</b>
<b>Summa:</b>	<b>0,0</b>

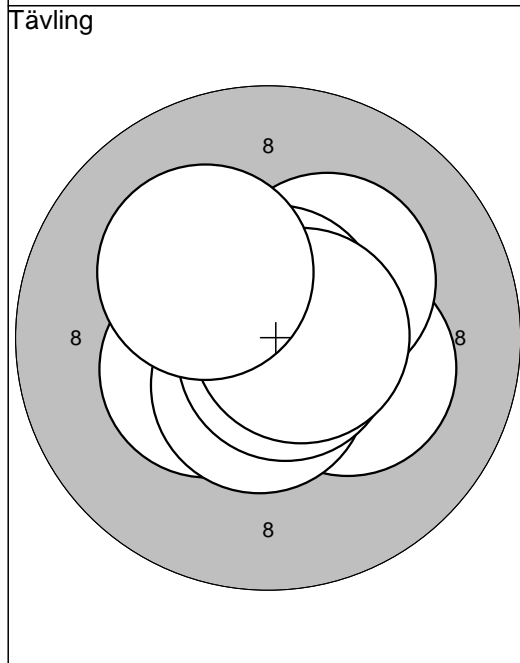

1: 10,2*	↘
2: 10,8*	↘
3: 10,3*	↗
4: 10,4*	↙
5: 10,8*	→
6: 10,7*	↑
7: 10,5*	↘
8: 10,8*	↘
9: 10,7*	→
10: 10,2*	↗
<b>Serie:</b>	<b>100,0</b>
<b>Summa:</b>	<b>100,0</b>

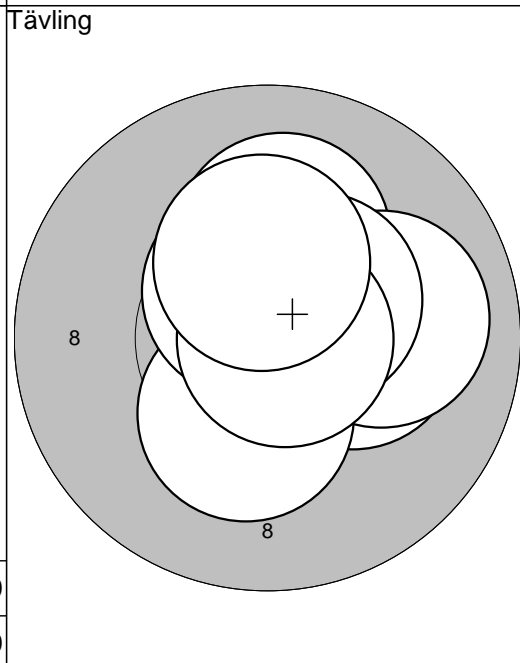

11: 10,1	↑
12: 10,2*	→
13: 10,8*	→
14: 10,3*	↘
15: 10,5*	↑
16: 10,5*	↑
17: 10,0	→
18: 10,5*	↗
19: 10,8*	→
20: 10,3*	↑
<b>Serie:</b>	<b>100,0</b>
<b>Summa:</b>	<b>200,0</b>

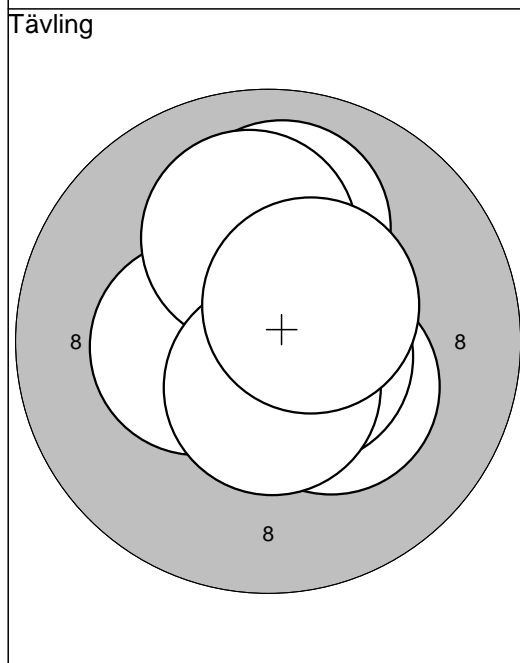

21: 10,3*	↘
22: 10,7*	↘
23: 10,8*	↘
24: 10,6*	↗
25: 10,4*	←
26: 10,0	↑
27: 10,1	↑
28: 10,6*	↘
29: 10,6*	↘
30: 10,5*	↗
<b>Serie:</b>	<b>100,0</b>
<b>Summa:</b>	<b>300,0</b>

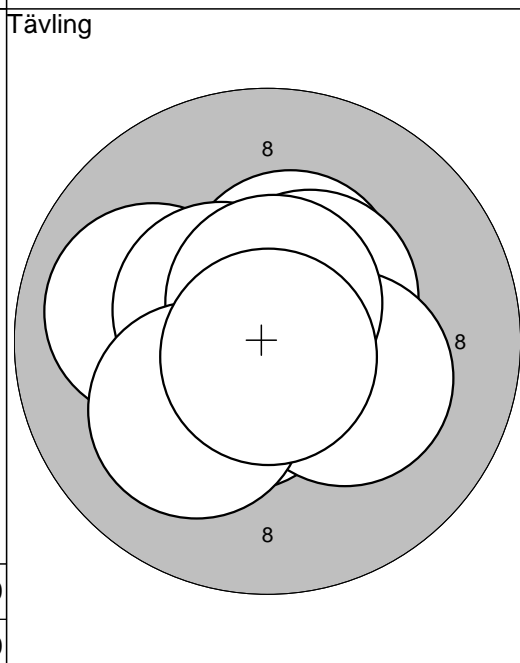

31: 10,0	←
32: 10,6*	↘
33: 10,4*	↑
34: 10,5*	↘
35: 10,4*	↗
36: 10,2*	↘
37: 10,5*	↖
38: 10,6*	↑
39: 10,1	↙
40: 10,8*	↘
<b>Serie:</b>	<b>100,0</b>
<b>Summa:</b>	<b>400,0</b>

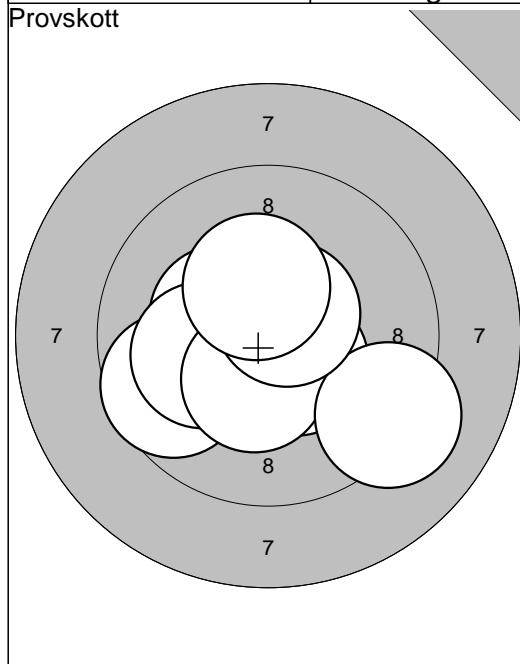

1: 9,6	↙
2: 10,9*	↙
3: 10,5*	↙
4: 10,4*	↙
5: 10,1	↙
6: 10,5*	↘
7: 10,4*	↘
8: 9,2	↘
9: 10,6*	↗
10: 10,3*	↑
Serie: 98,0	
Summa: 0,0	

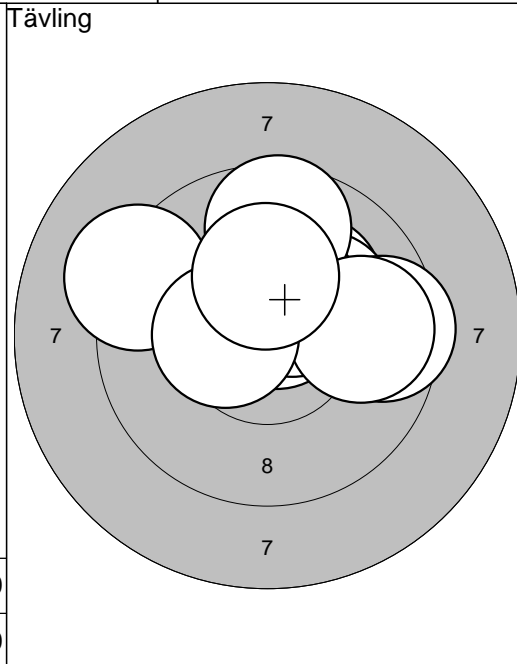

1: 10,7*	↗
2: 10,2*	↗
3: 10,2*	↗
4: 9,5	→
5: 10,5*	↗
6: 9,6	↑
7: 9,2	↙
8: 9,8	→
9: 10,4*	↙
10: 10,2*	↑
Serie: 96,0	
Summa: 96,0	

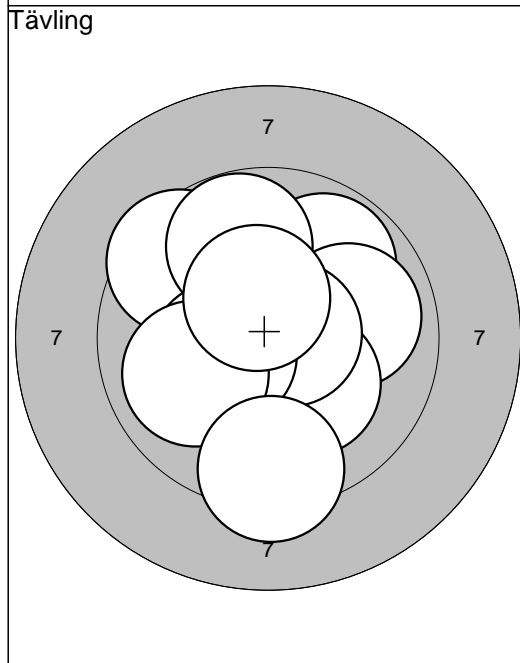

11: 9,8	↗
12: 9,9	→
13: 9,5	↗
14: 9,8	↑
15: 10,2*	↘
16: 10,7*	→
17: 10,4*	↙
18: 10,0	↙
19: 10,4*	↑
20: 9,3	↓
Serie: 95,0	
Summa: 191,0	

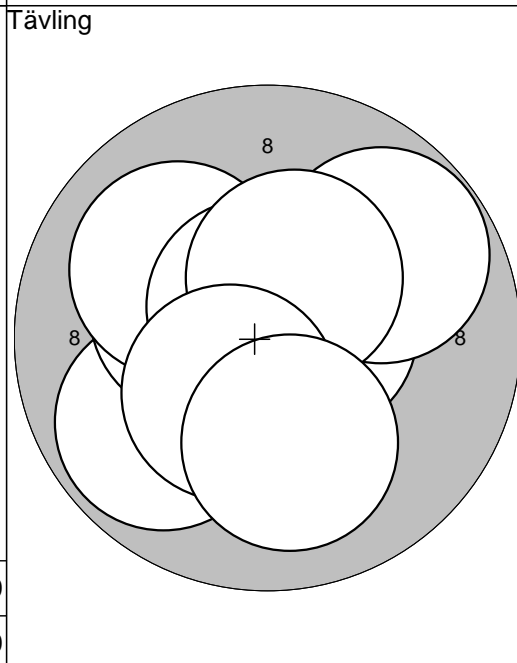

21: 9,8	↙
22: 10,3*	↙
23: 10,5*	↘
24: 10,6*	→
25: 10,0	↙
26: 9,8	↗
27: 10,7*	↑
28: 10,4*	↗
29: 10,4*	↘
30: 10,1	↓
Serie: 98,0	
Summa: 289,0	

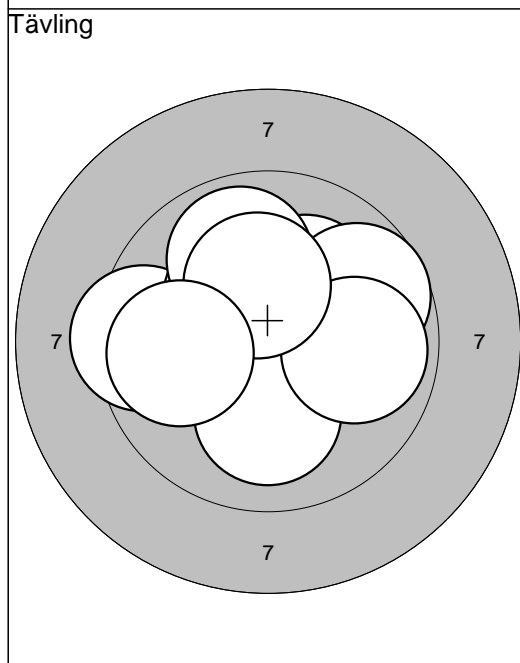

31: 10,2*	↗
32: 9,4	↙
33: 10,3*	↗
34: 10,2*	↗
35: 9,9	↑
36: 10,1	↓
37: 9,7	↗
38: 9,9	→
39: 10,3*	↑
40: 9,9	↙
Serie: 95,0	
Summa: 384,0	

# Provskott

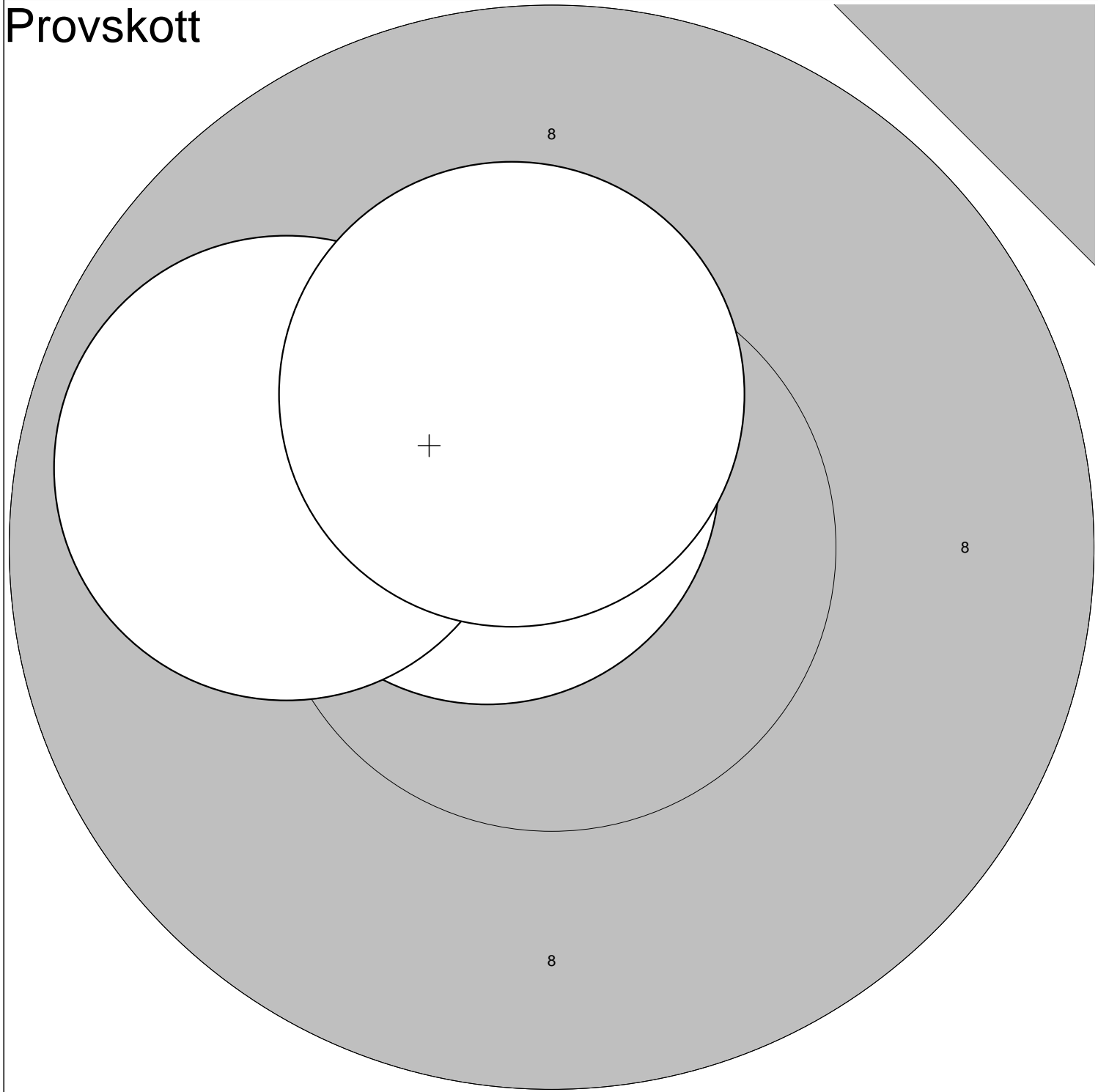

1:10,6\* ↗  
2: 9,9 ↖  
3:10,3\* ↗

**Serie: 29,0**

**Summa: 0,0**