

1: 10,5*	↘
2: 10,2*	←
3: 10,3*	←
4: 10,2*	←
5: 10,3*	↙
6: 9,8	↘
7: 10,2*	→
8: 10,7*	↘
9: 10,7*	↘
10: 10,2*	←
Serie:	99,0
Summa:	0,0

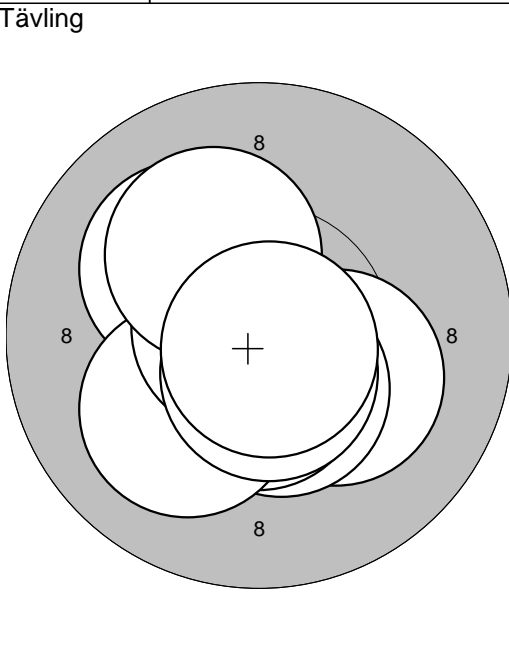

1: 10,2*	↘
2: 10,7*	↙
3: 10,5*	↘
4: 10,1	↗
5: 10,6*	↘
6: 10,1	↙
7: 10,8*	←
8: 10,6*	↘
9: 10,2*	↗
10: 10,8*	↘
Serie:	100,0
Summa:	100,0

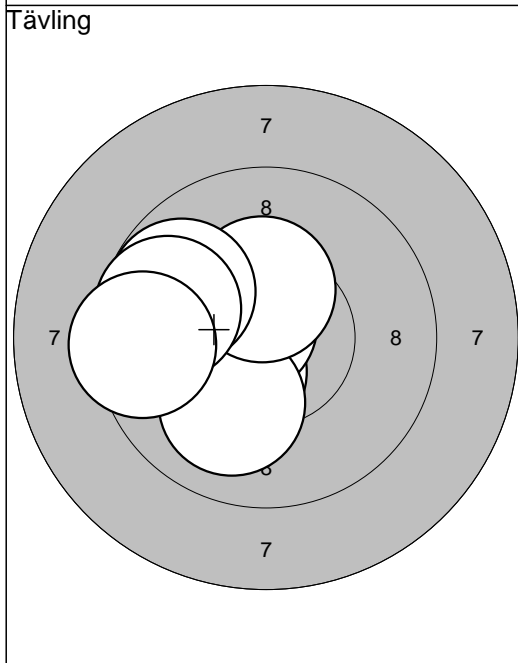

11: 10,4*	↗
12: 10,1	↙
13: 10,5*	←
14: 10,4*	↙
15: 10,6*	↗
16: 10,0	↘
17: 10,4*	↑
18: 9,8	↙
19: 9,7	←
20: 9,4	←
Serie:	97,0
Summa:	197,0

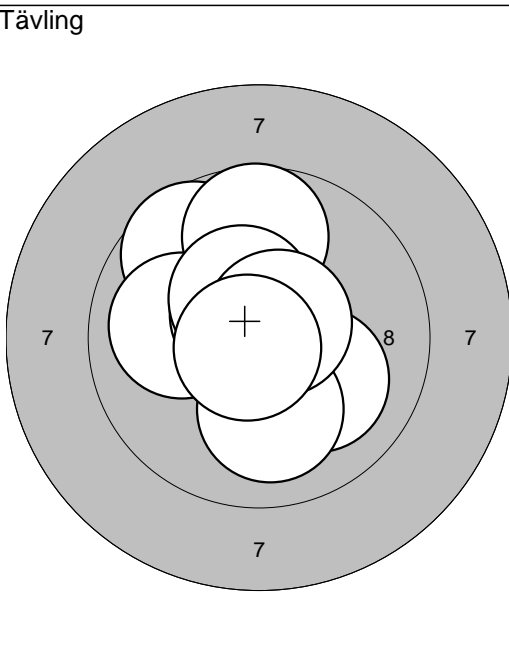

21: 10,3*	↙
22: 9,7	↗
23: 10,0	←
24: 10,1	↘
25: 9,7	↑
26: 10,6*	↗
27: 10,4*	↗
28: 10,1	↘
29: 10,7*	↗
30: 10,8*	↘
Serie:	98,0
Summa:	295,0

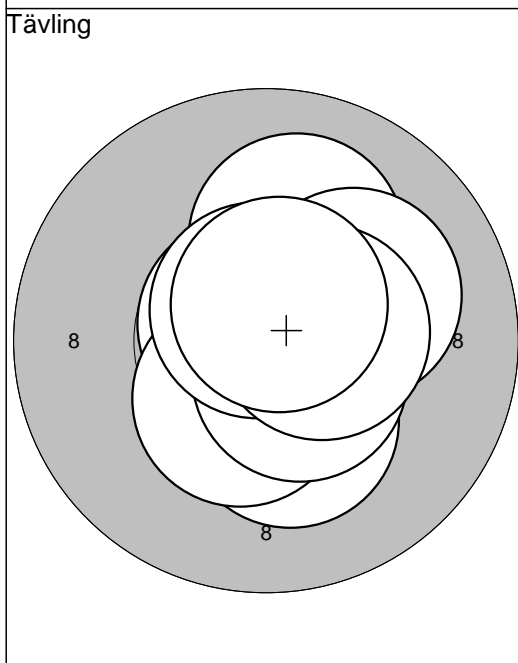

31: 10,7*	↙
32: 10,6*	↗
33: 10,3*	↘
34: 10,4*	↘
35: 10,1	↗
36: 10,6*	↘
37: 10,1	↗
38: 10,7*	↑
39: 10,5*	→
40: 10,6*	↗
Serie:	100,0
Summa:	395,0

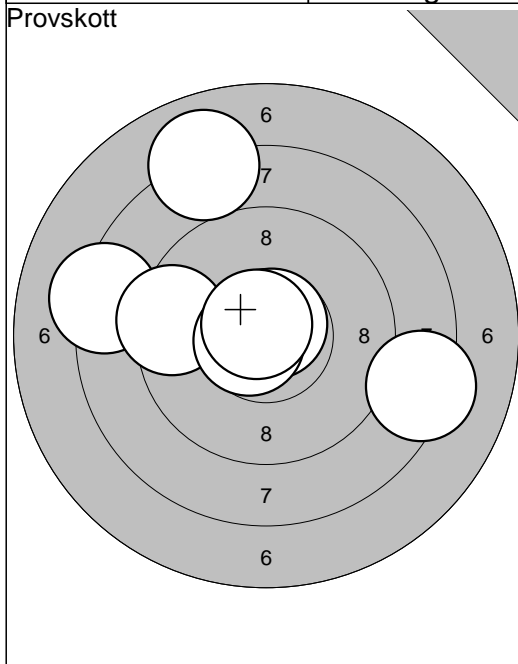

1: 8,3	➔
2: 8,3	➔
3: 9,4	➔
4: 8,0	➔
5: 10,7*	➔
6: 10,7*	➔
7: 10,7*	➔
<b>Serie: 63,0</b>	
<b>Summa: 0,0</b>	

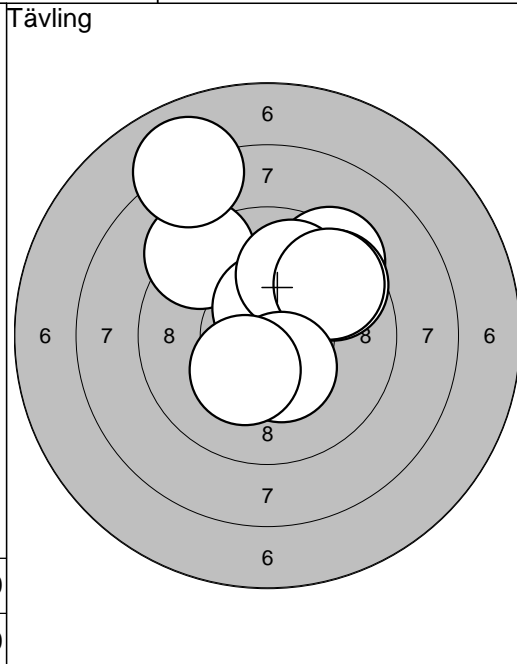

1: 9,4	➔
2: 9,9	➔
3: 9,2	➔
4: 8,0	➔
5: 10,5*	➔
6: 9,9	➔
7: 9,6	➔
8: 9,6	➔
9: 10,4*	➔
10: 10,3*	➔
<b>Serie: 92,0</b>	
<b>Summa: 92,0</b>	

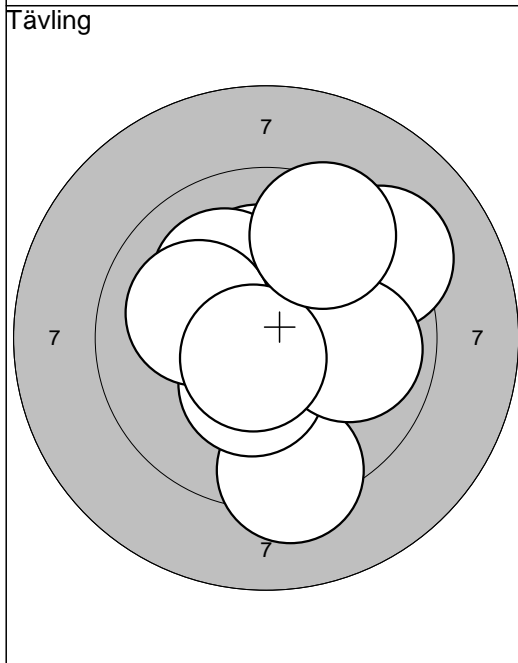

11: 10,2*	➔
12: 9,3	➔
13: 10,9*	➔
14: 10,4*	➔
15: 10,1	➔
16: 9,2	➔
17: 10,1	➔
18: 9,9	➔
19: 10,7*	➔
20: 9,5	➔
<b>Serie: 96,0</b>	
<b>Summa: 188,0</b>	

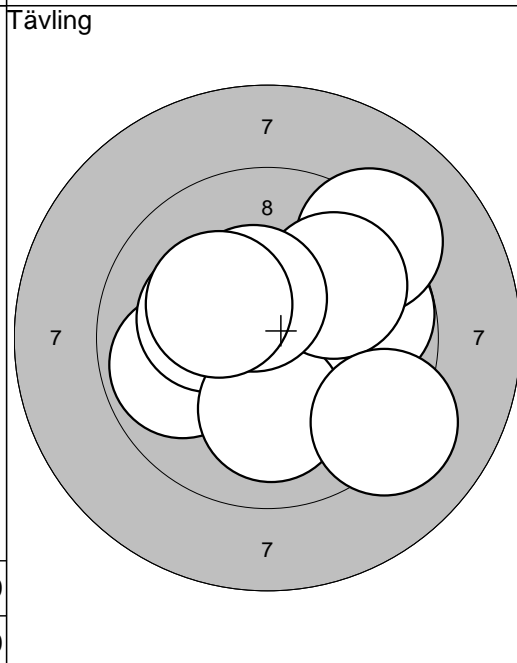

21: 9,8	➔
22: 10,4*	➔
23: 9,9	➔
24: 9,2	➔
25: 10,2*	➔
26: 10,1	➔
27: 9,9	➔
28: 10,4*	➔
29: 9,2	➔
30: 10,2*	➔
<b>Serie: 95,0</b>	
<b>Summa: 283,0</b>	

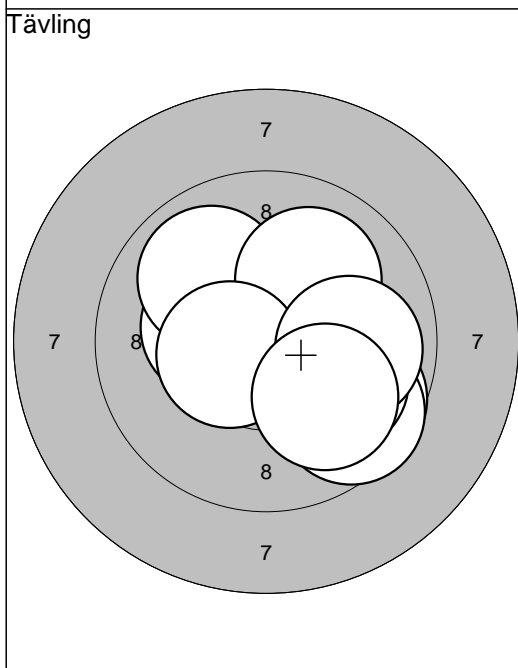

31: 9,7	➔
32: 10,3*	➔
33: 9,9	➔
34: 9,6	➔
35: 10,1	➔
36: 10,0	➔
37: 10,0	➔
38: 10,5*	➔
39: 9,9	➔
40: 10,0	➔
<b>Serie: 96,0</b>	
<b>Summa: 379,0</b>	

Provskott

1: 10,7*	↑
2: 10,2*	↓
3: 10,7*	↑
4: 10,4*	↖
5: 10,3*	←
Serie: 50,0	
Summa: 0,0	

Tävling

1: 10,2*	↗
2: 10,5*	←
3: 10,3*	→
4: 10,6*	↑
5: 9,6	↓
6: 10,1	↗
7: 10,4*	↖
8: 10,0	↑
9: 10,1	↗
10: 10,3*	→
Serie: 99,0	
Summa: 99,0	

Tävling

11: 9,6	↗
12: 9,5	↓
13: 10,3*	↑
14: 10,1	↑
15: 9,9	↗
16: 10,1	↑
17: 9,5	↑
18: 10,4*	↑
19: 10,1	↖
20: 9,8	↗
Serie: 95,0	
Summa: 194,0	

Tävling

21: 10,3*	←
22: 10,0	↖
23: 10,8*	↖
24: 10,1	↗
25: 9,9	↗
26: 9,3	↑
27: 9,5	↖
28: 10,2*	↑
29: 9,7	↖
30: 10,1	↗
Serie: 96,0	
Summa: 290,0	

Tävling

31: 9,5	↗
32: 9,1	↖
33: 10,4*	↑
34: 10,2*	↓
35: 10,3*	↓
36: 9,6	→
37: 9,4	↗
38: 10,7*	↘
39: 10,1	→
40: 10,1	↓
Serie: 96,0	
Summa: 386,0	

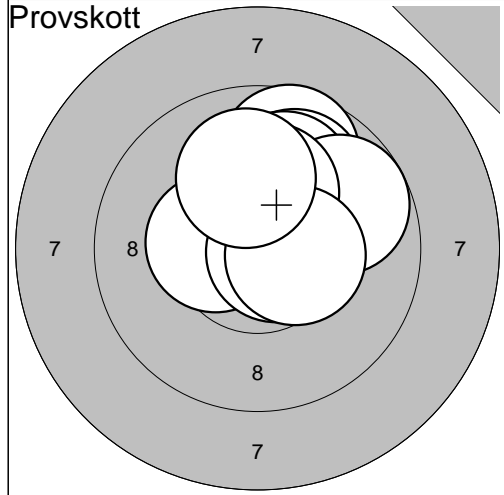

1: 9,7	↗
2: 9,9	↗
3: 10,0	↗
4: 9,8	→
5: 10,3*	↗
6: 10,2*	↗
7: 10,4*	←
8: 10,7*	→
9: 10,4*	→
10: 10,0	↗
<b>Serie:</b>	<b>97,0</b>
<b>Summa:</b>	<b>0,0</b>

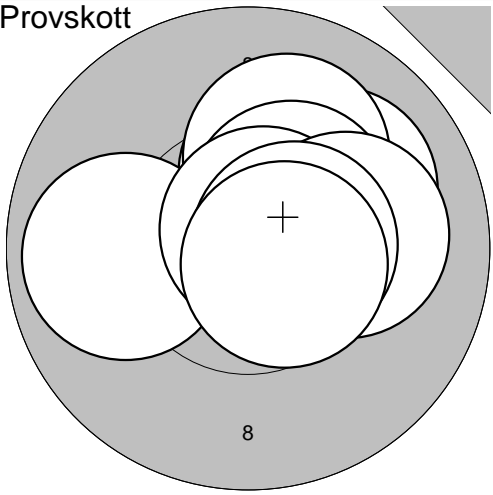

11: 10,2*	↗
12: 10,2*	↗
13: 10,0	↗
14: 9,9	←
15: 10,1	↗
16: 10,4*	↗
17: 10,7*	↗
18: 10,1	→
19: 10,5*	→
20: 10,6*	→
<b>Serie:</b>	<b>99,0</b>
<b>Summa:</b>	<b>0,0</b>

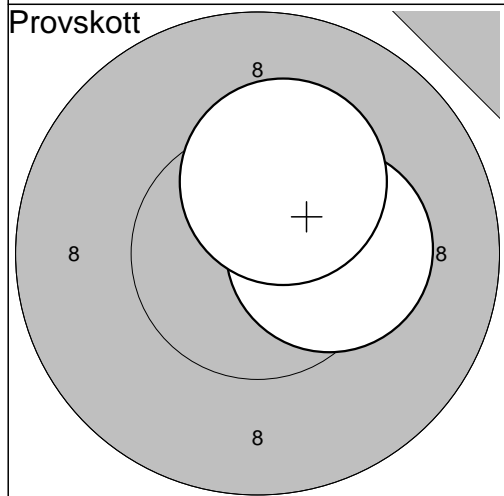

21: 10,3*	→
22: 10,3*	↗
<b>Serie:</b>	<b>20,0</b>
<b>Summa:</b>	<b>0,0</b>

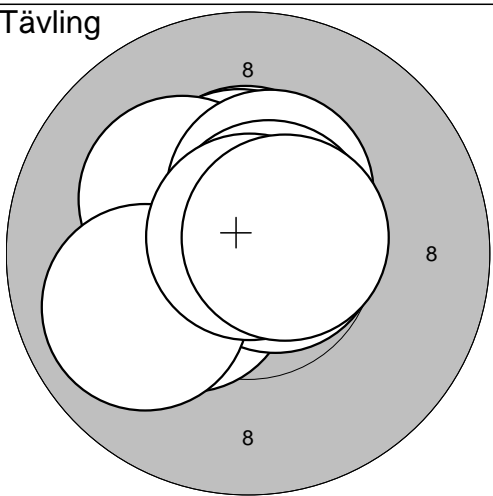

1: 10,3*	←
2: 10,7*	→
3: 10,4*	↗
4: 10,4*	↗
5: 10,2*	↖
6: 10,4*	↗
7: 9,9	←
8: 10,6*	↗
9: 10,8*	↗
10: 10,6*	→
<b>Serie:</b>	<b>99,0</b>
<b>Summa:</b>	<b>99,0</b>

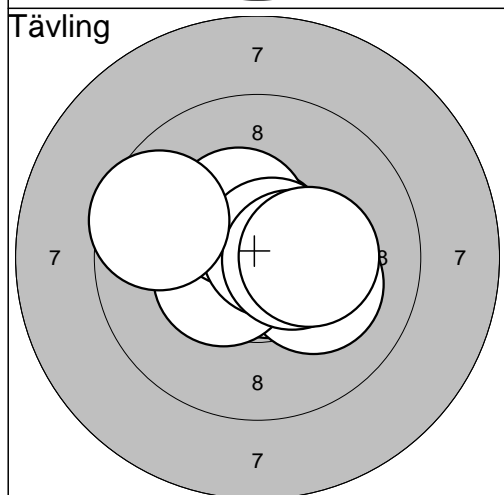

11: 10,2*	←
12: 10,7*	↘
13: 10,7*	↗
14: 10,1	→
15: 10,5*	←
16: 10,4*	↗
17: 10,7*	↗
18: 10,5*	→
19: 10,3*	→
20: 9,6	←
<b>Serie:</b>	<b>99,0</b>
<b>Summa:</b>	<b>198,0</b>

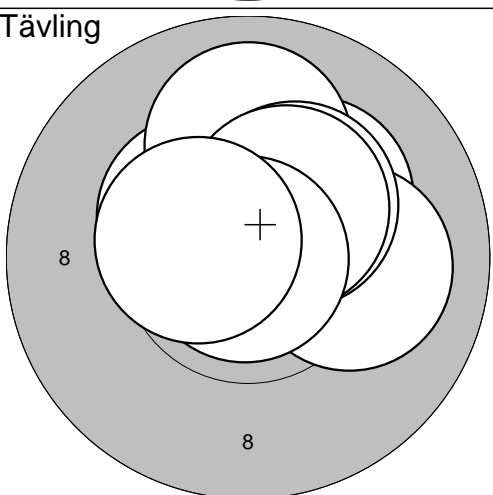

21: 10,2*	↗
22: 10,8*	↖
23: 10,1	→
24: 10,4*	↖
25: 10,0	↗
26: 10,3*	↗
27: 10,8*	↖
28: 10,4*	↗
29: 10,9*	←
30: 10,5*	←
<b>Serie:</b>	<b>100,0</b>
<b>Summa:</b>	<b>298,0</b>

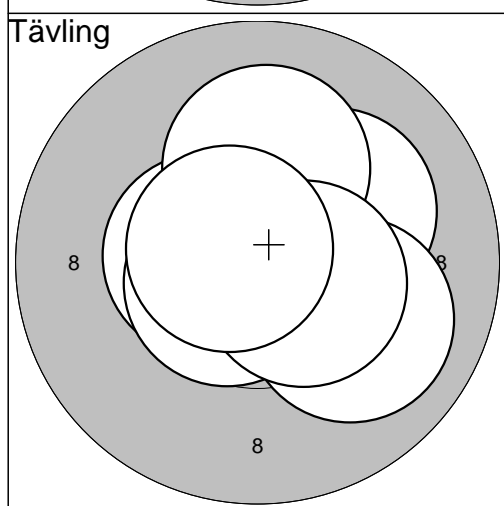

31: 10,5*	↗
32: 10,2*	↗
33: 10,5*	←
34: 10,7*	↗
35: 10,6*	↖
36: 10,0	↘
37: 10,7*	↗
38: 10,1	↗
39: 10,5*	↘
40: 10,7*	↖
<b>Serie:</b>	<b>100,0</b>
<b>Summa:</b>	<b>398,0</b>

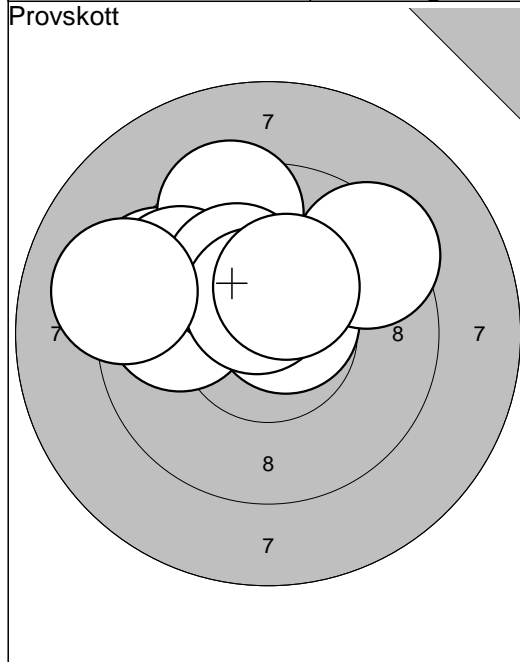

1: 9,5	↖
2: 9,4	↑
3: 9,7	↖
4: 9,9	←
5: 10,7*	↗
6: 10,2*	↗
7: 10,5*	↑
8: 9,1	←
9: 9,4	↗
10: 10,3*	↗
Serie:	94,0
Summa:	0,0

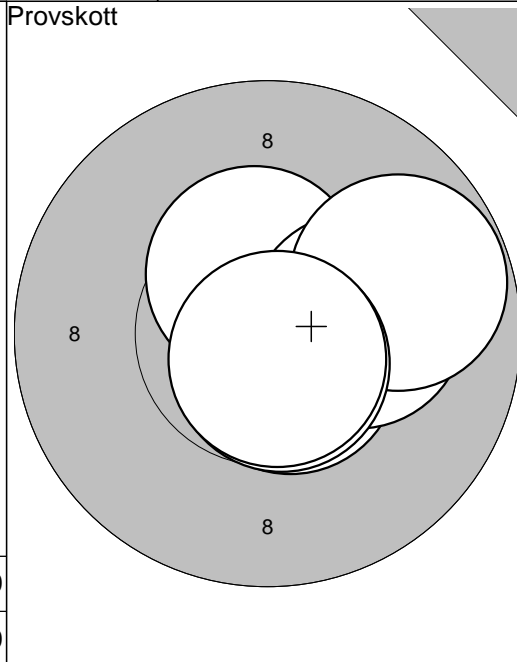

11: 10,5*	↗
12: 10,4*	↑
13: 10,6*	↘
14: 10,2*	→
15: 9,8	↗
16: 10,7*	↘
17: 10,7*	↘
Serie:	69,0
Summa:	0,0

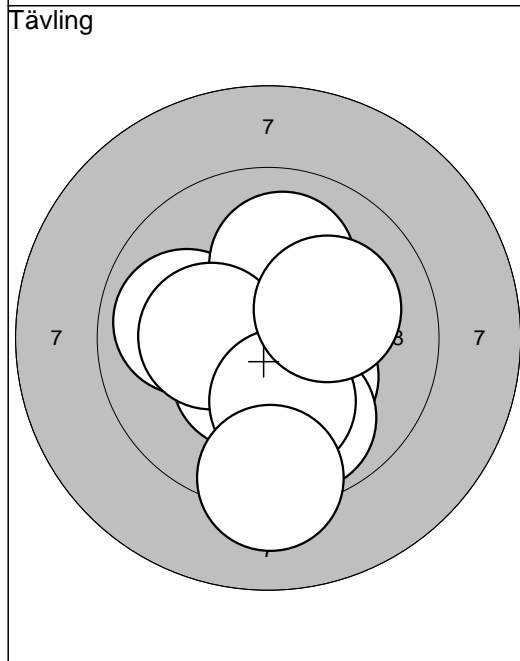

1: 10,3*	←
2: 10,3*	↘
3: 9,9	←
4: 10,0	↑
5: 10,4*	↘
6: 10,3*	←
7: 9,9	↘
8: 10,1	↘
9: 9,2	↘
10: 10,1	↗
Serie:	97,0
Summa:	97,0

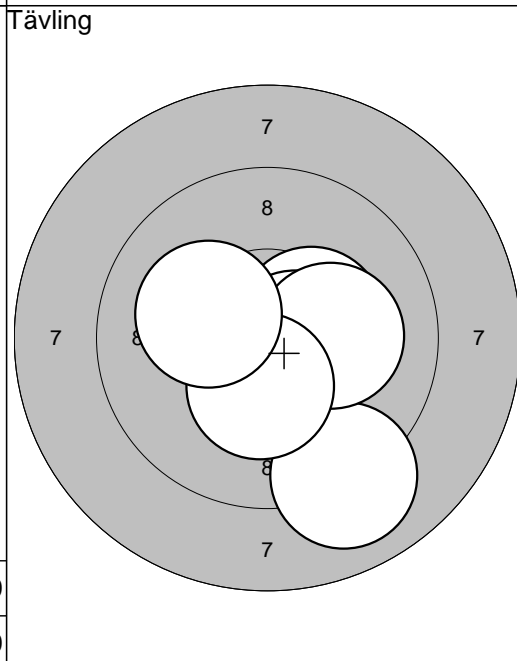

11: 10,4*	↗
12: 10,9*	↘
13: 10,8*	↘
14: 10,8*	↖
15: 10,4*	↗
16: 9,0	↘
17: 10,6*	↗
18: 10,2*	→
19: 10,4*	↘
20: 10,2*	↖
Serie:	99,0
Summa:	196,0

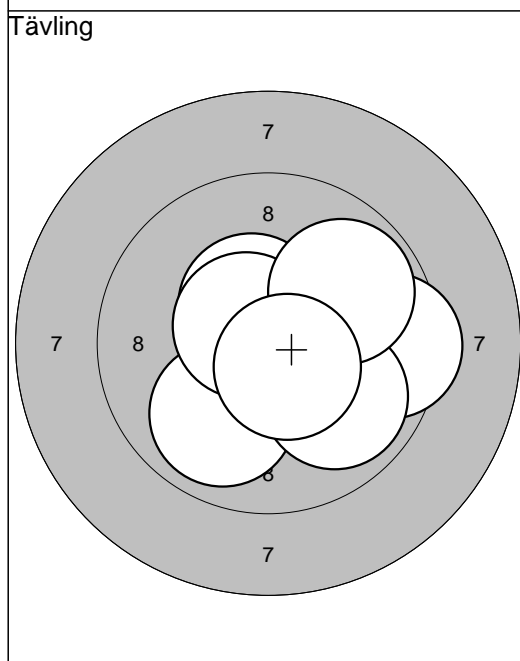

21: 10,6*	↘
22: 10,5*	↗
23: 10,7*	↘
24: 9,9	↘
25: 10,5*	↑
26: 9,5	→
27: 9,9	↘
28: 10,6*	↗
29: 9,8	↗
30: 10,6*	↘
Serie:	96,0
Summa:	292,0

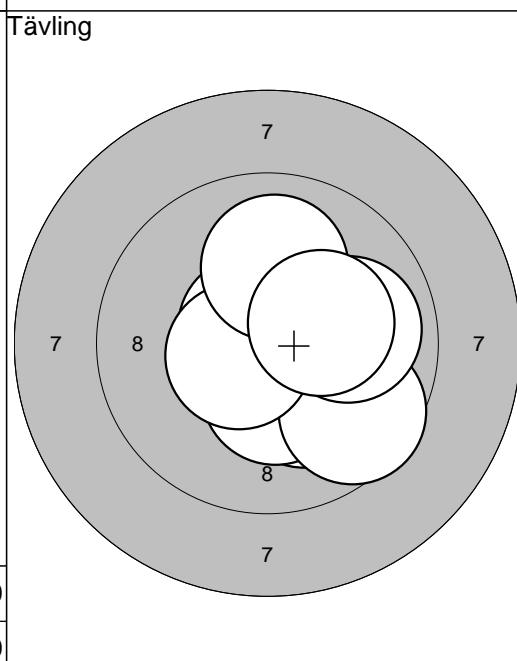

31: 10,2*	↘
32: 10,6*	→
33: 10,3*	↘
34: 9,6	↘
35: 10,6*	↑
36: 10,7*	↖
37: 9,9	→
38: 10,6*	↖
39: 10,0	↑
40: 10,2*	↗
Serie:	98,0
Summa:	390,0

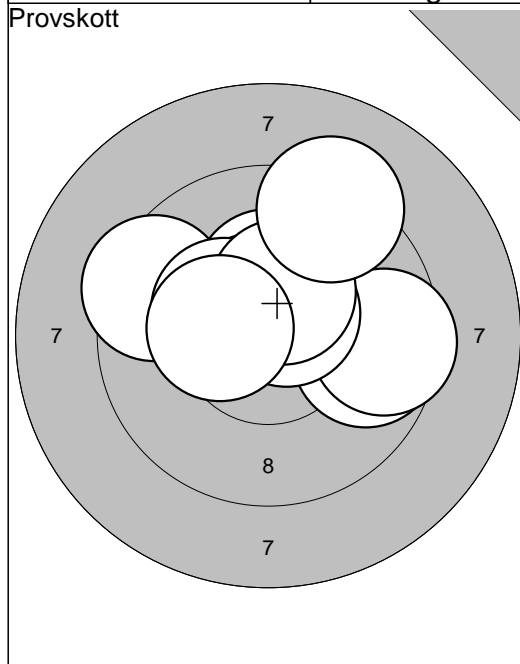

1: 10,3*	↑
2: 9,7	→
3: 10,6*	↑
4: 9,4	←
5: 9,5	→
6: 10,3*	↖
7: 10,6*	↗
8: 10,4*	↑
9: 10,4*	←
10: 9,2	↗
Serie:	96,0
Summa:	0,0

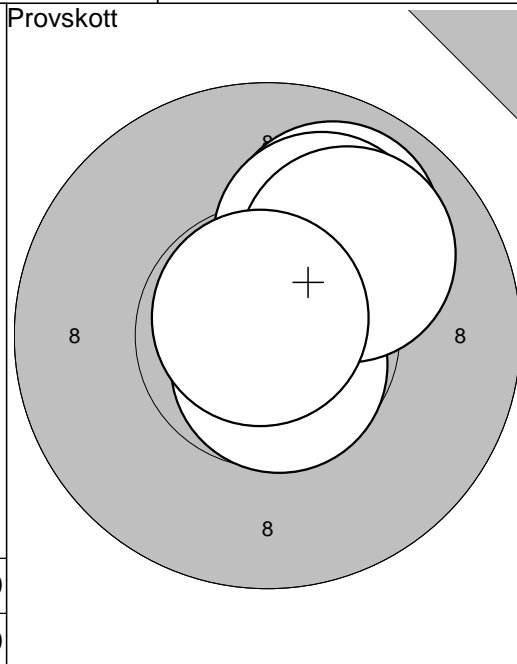

11: 10,7*	↘
12: 9,9	↗
13: 10,0	↗
14: 10,0	↗
15: 10,8*	↖
Serie:	49,0
Summa:	0,0

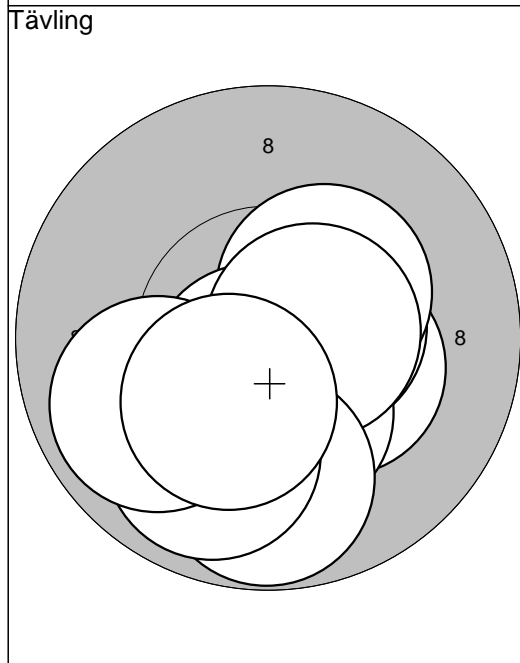

1: 10,3*	↘
2: 10,5*	→
3: 10,3*	↗
4: 10,3*	↓
5: 10,6*	↓
6: 10,6*	→
7: 9,8	↓
8: 9,9	↓
9: 9,9	←
10: 10,3*	↘
Serie:	97,0
Summa:	97,0

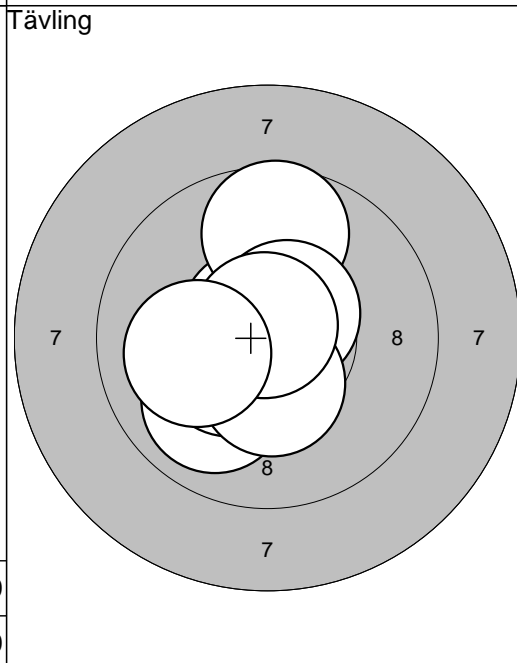

11: 10,7*	↖
12: 10,5*	←
13: 10,9*	↗
14: 10,0	↘
15: 9,7	↑
16: 10,4*	↘
17: 10,6*	↗
18: 10,4*	↓
19: 10,8*	↑
20: 10,1	←
Serie:	99,0
Summa:	196,0

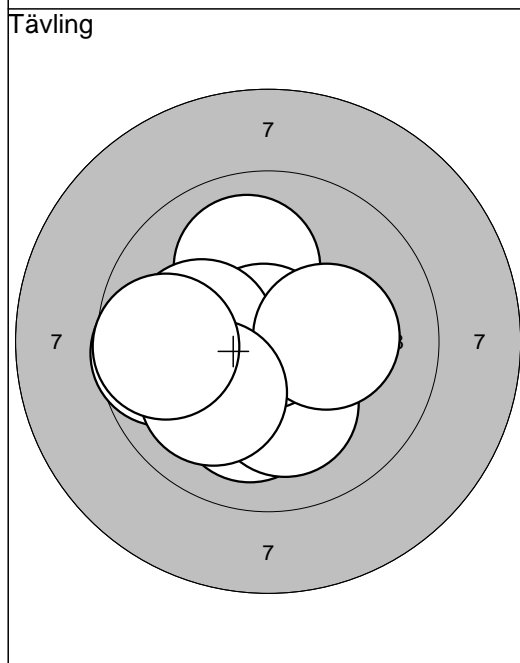

21: 10,2*	←
22: 10,1	↓
23: 10,2*	↓
24: 10,0	↑
25: 9,7	←
26: 10,9*	↖
27: 10,1	←
28: 10,2*	→
29: 10,0	↘
30: 9,7	←
Serie:	98,0
Summa:	294,0

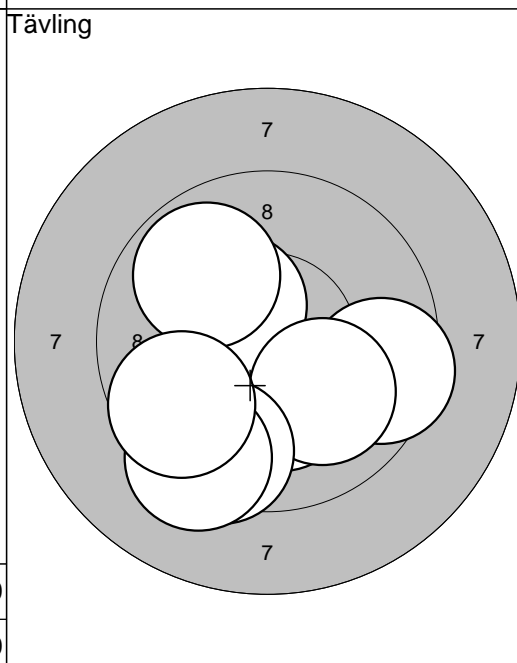

31: 9,5	→
32: 10,0	↓
33: 10,2*	↓
34: 10,2*	↘
35: 10,4*	↖
36: 9,9	↗
37: 10,0	↘
38: 9,5	↓
39: 9,3	↘
40: 9,6	↘
Serie:	95,0
Summa:	389,0

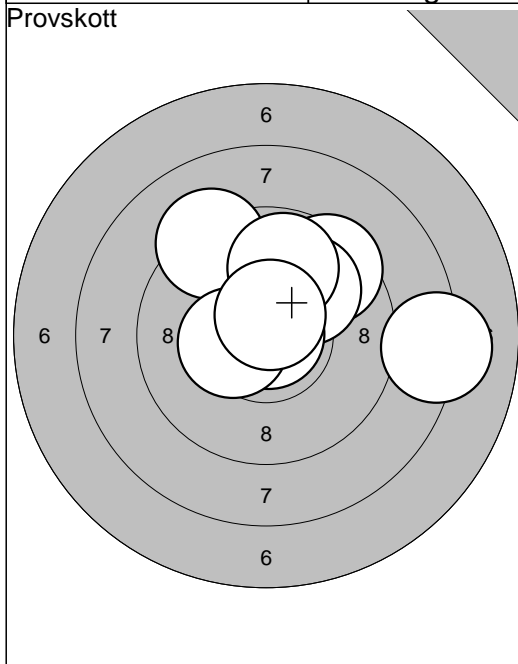

1: 9,2	↖
2: 9,5	↗
3: 10,0	↗
4: 9,8	↑
5: 10,9*	→
6: 8,2	→
7: 10,4*	←
8: 10,6*	↑
Serie: 75,0	
Summa: 0,0	

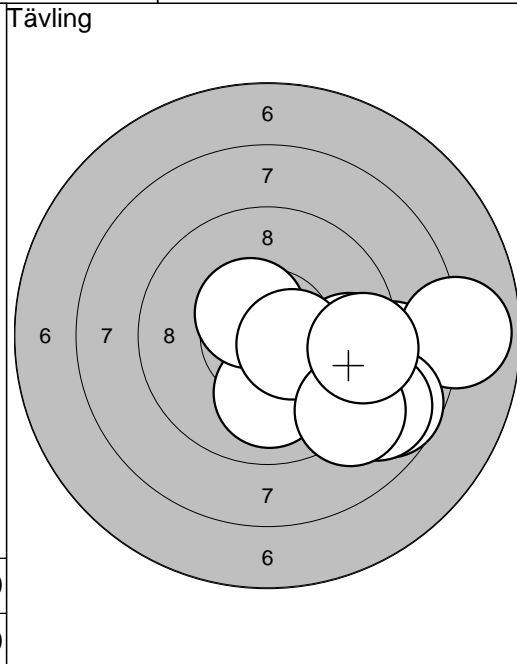

1: 10,0	↓
2: 8,9	→
3: 9,6	→
4: 10,5*	↗
5: 7,9	→
6: 10,5*	→
7: 8,7	↘
8: 8,8	↘
9: 9,1	↘
10: 9,4	→
Serie: 88,0	
Summa: 88,0	

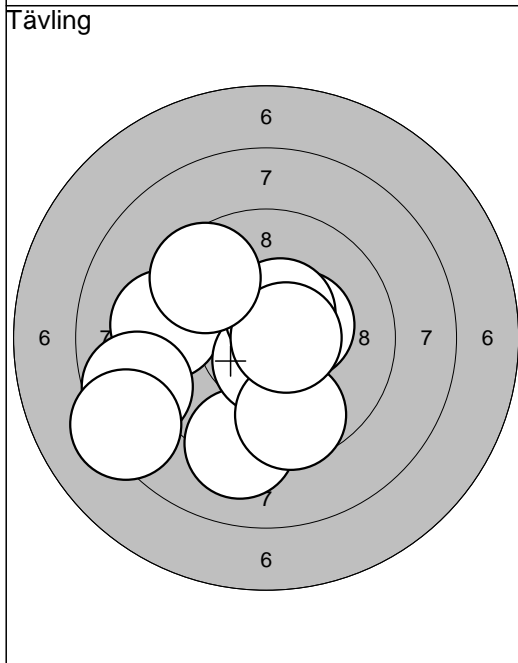

11: 9,2	↓
12: 9,3	←
13: 10,4*	→
14: 10,6*	↓
15: 8,7	←
16: 9,6	↓
17: 10,5*	↗
18: 10,6*	→
19: 8,3	←
20: 9,6	↖
Serie: 92,0	
Summa: 180,0	

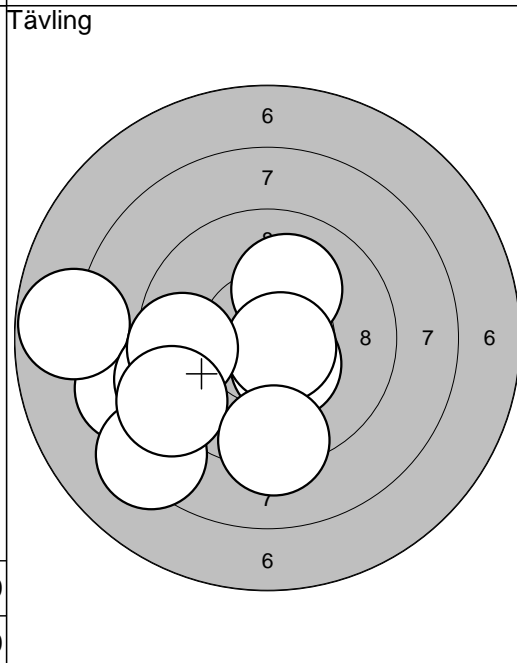

21: 10,4*	↘
22: 10,1	↗
23: 8,6	←
24: 10,7*	↘
25: 7,8	←
26: 9,2	←
27: 8,3	↘
28: 9,6	←
29: 9,1	↘
30: 9,3	↓
Serie: 89,0	
Summa: 269,0	

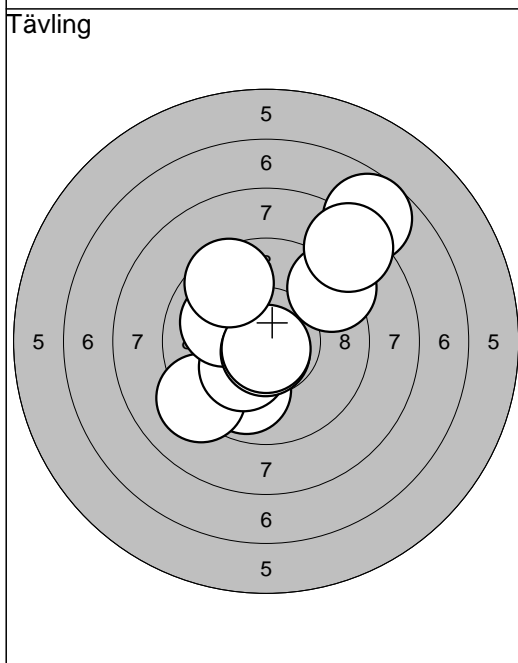

31: 9,9	↘
32: 9,2	↘
33: 9,2	↗
34: 10,3*	↘
35: 10,0	↖
36: 10,7*	↓
37: 10,8*	↓
38: 9,6	↖
39: 7,7	↗
40: 8,4	↗
Serie: 91,0	
Summa: 360,0	