

Lag <b>1</b>	Tavla <b>1</b>	
-----------------	-------------------	--

Gövisken

05.02.2011 Skyttiaden Regionsfinal Mörsils SKF

# Provskott

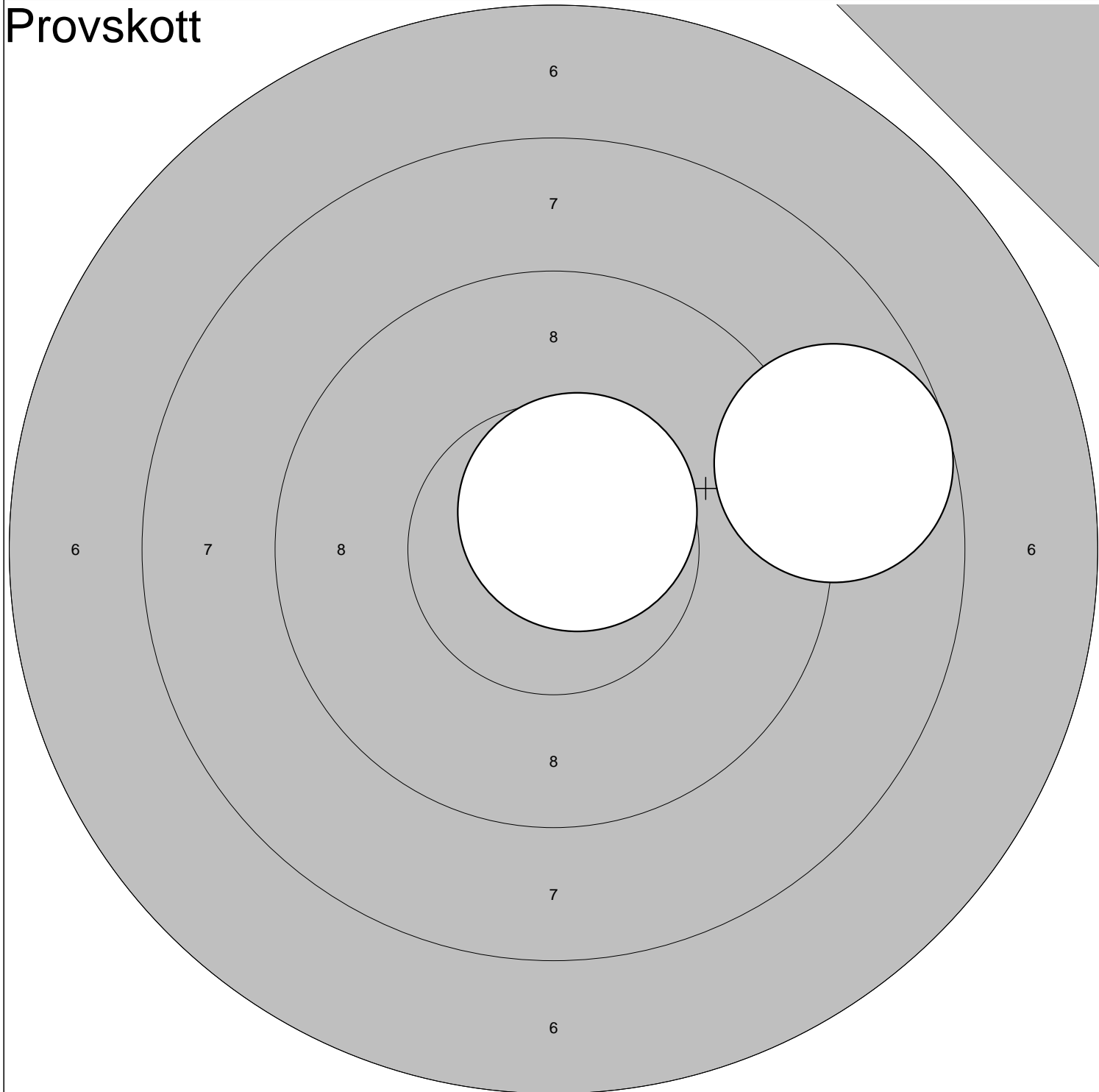

1: 8,7 →  
2: 10,6\* ↗

Serie: 19,3

Summa: 0,0

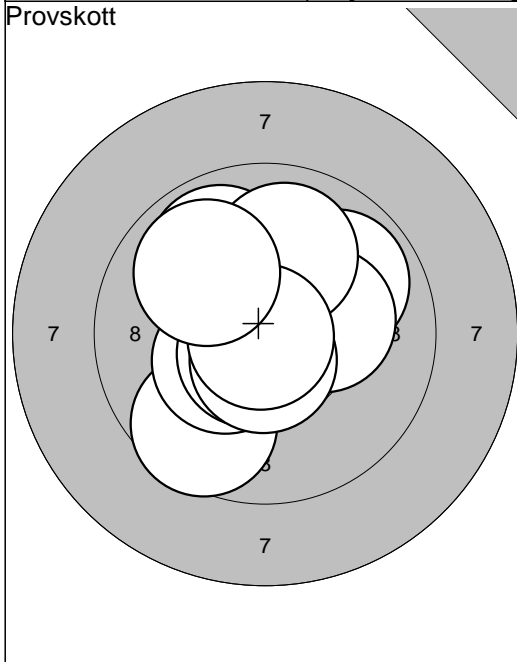

1: 9,9	↖
2: 9,9	↗
3: 10,2*	→
4: 9,6	↙
5: 10,0	↑
6: 10,4*	←
7: 10,6*	↙
8: 10,6*	↓
9: 10,9*	↙
10: 9,9	↖
Serie: 102,0	
Summa: 0,0	

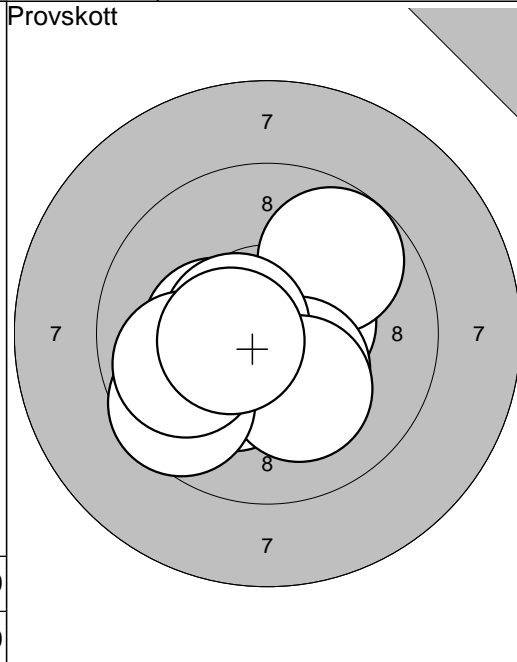

11: 10,5*	→
12: 10,3*	←
13: 10,3*	↙
14: 9,8	↗
15: 10,4*	↙
16: 10,6*	←
17: 10,2*	↙
18: 9,6	↙
19: 9,9	←
20: 10,5*	←
Serie: 102,1	
Summa: 0,0	

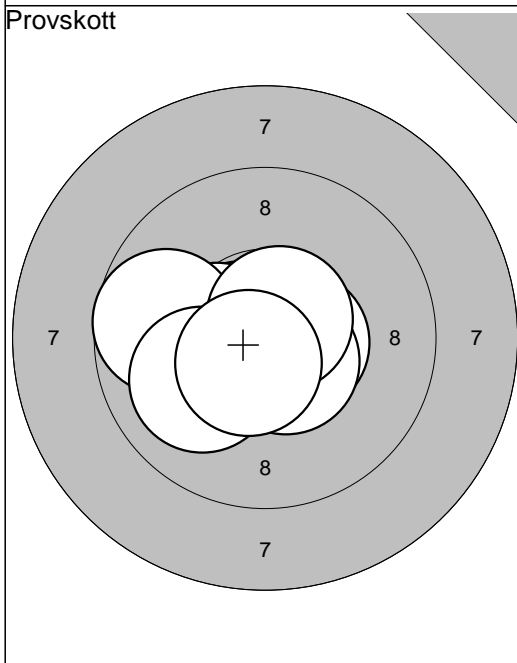

21: 10,7*	←
22: 10,4*	←
23: 10,6*	→
24: 9,7	←
25: 10,6*	↙
26: 10,0	←
27: 10,7*	↗
28: 10,6*	↙
Serie: 83,3	
Summa: 0,0	

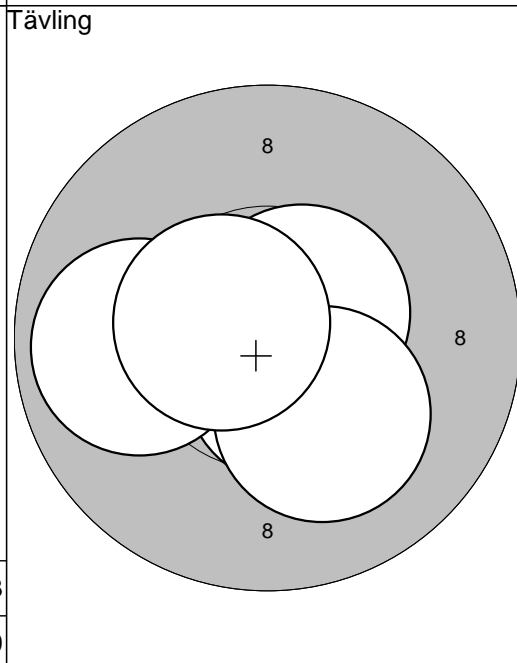

1: 10,5*	↙
2: 10,6*	↗
3: 9,9	←
4: 10,2*	↙
5: 10,6*	←
Serie: 51,8	
Summa: 51,8	

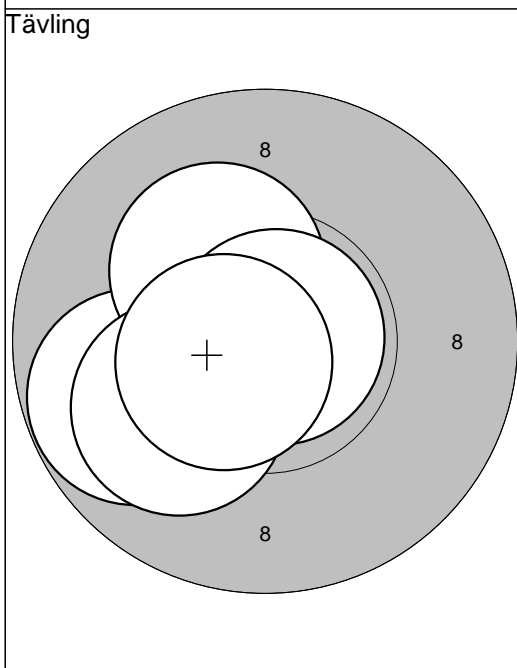

6: 9,8	←
7: 10,2*	↖
8: 10,9*	→
9: 10,1	↙
10: 10,6*	←
Serie: 51,6	
Summa: 103,4	

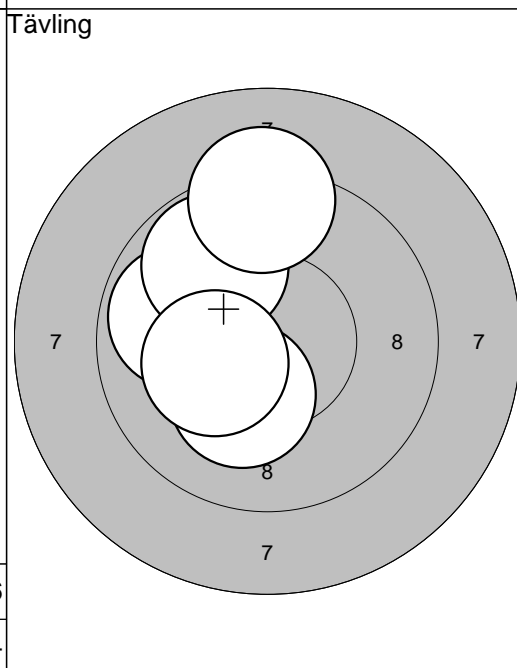

11: 9,9	←
12: 9,8	↖
13: 10,2*	↙
14: 9,2	↑
15: 10,3*	←
Serie: 49,4	
Summa: 152,8	

**Tävling**

16: 10,4*	↓
17: 9,8	↙
18: 9,9	↓
19: 10,5*	↗
20: 10,6*	→
<b>Serie:</b>	<b>51,2</b>
<b>Summa:</b>	<b>204,0</b>

**Tävling**

21: 10,4*	↓
22: 9,3	↙
23: 10,1	↓
24: 10,2*	↗
25: 10,7*	↖
<b>Serie:</b>	<b>50,7</b>
<b>Summa:</b>	<b>254,7</b>

**Tävling**

26: 9,3	↖
27: 10,5*	↘
28: 10,0	↙
29: 10,6*	↗
30: 9,8	↓
<b>Serie:</b>	<b>50,2</b>
<b>Summa:</b>	<b>304,9</b>

**Tävling**

31: 10,4*	→
32: 10,7*	↑
33: 10,1	↙
34: 10,2*	↗
35: 10,5*	↖
<b>Serie:</b>	<b>51,9</b>
<b>Summa:</b>	<b>356,8</b>

**Tävling**

36: 10,4*	↙
37: 10,3*	↘
38: 9,7	↖
39: 10,2*	↓
40: 10,1	↘
<b>Serie:</b>	<b>50,7</b>
<b>Summa:</b>	<b>407,5</b>

--	--

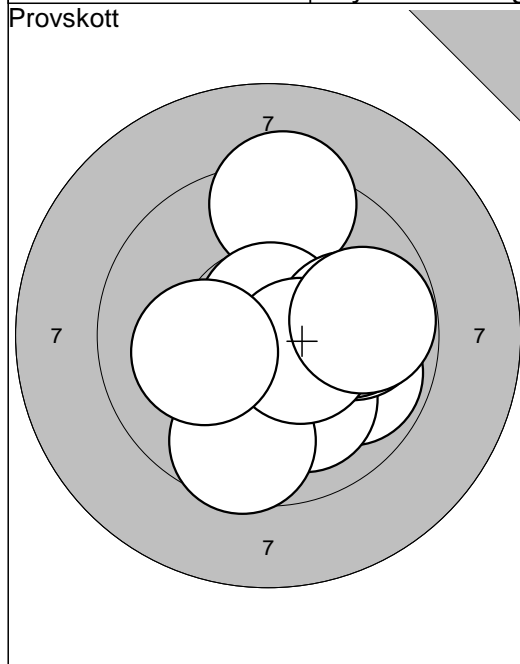

1: 9,3	↑
2: 10,7*	↑
3: 9,8	↘
4: 10,1	↘
5: 9,6	↓
6: 9,9	→
7: 10,0	→
8: 10,5*	↘
9: 9,8	→
10: 10,1	←
Serie: 99,8	
Summa: 0,0	

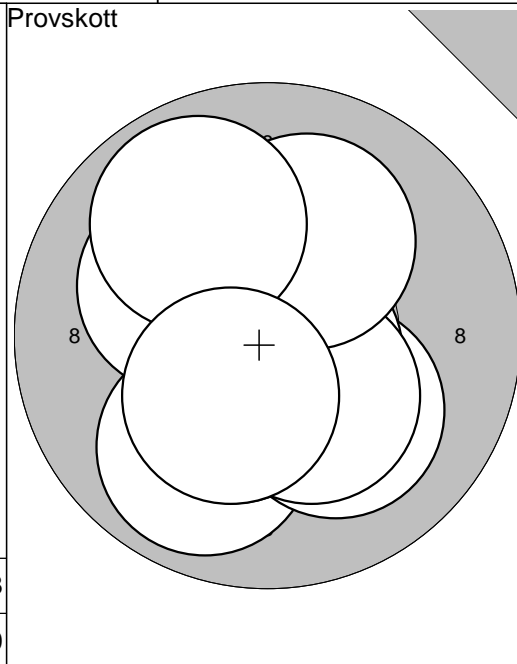

11: 9,9	↘
12: 10,6*	↗
13: 10,1	↘
14: 10,7*	↘
15: 10,4*	↘
16: 10,2*	↖
17: 10,3*	↘
18: 10,1	↗
19: 9,9	↖
20: 10,4*	↘
Serie: 102,6	
Summa: 0,0	

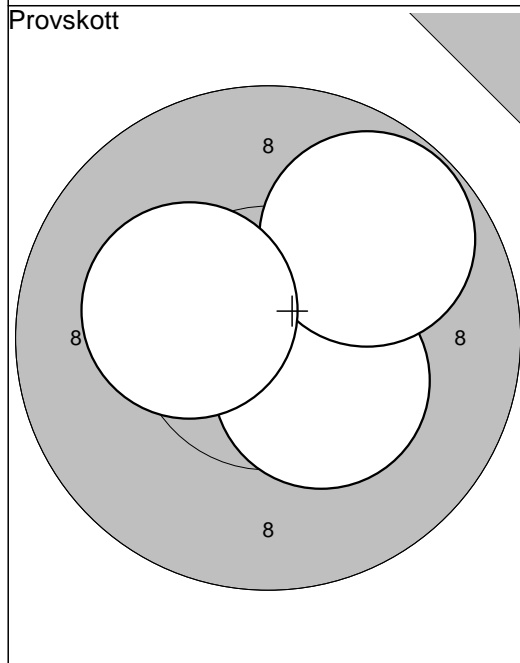

21: 10,4*	↘
22: 9,8	↗
23: 10,3*	←
Serie: 30,5	
Summa: 0,0	

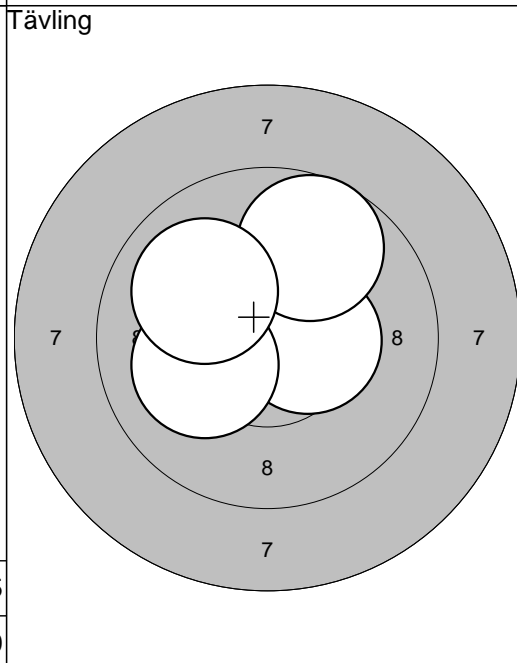

1: 10,6*	←
2: 10,4*	→
3: 9,7	↗
4: 10,1	←
5: 10,0	↖
Serie: 50,8	
Summa: 50,8	

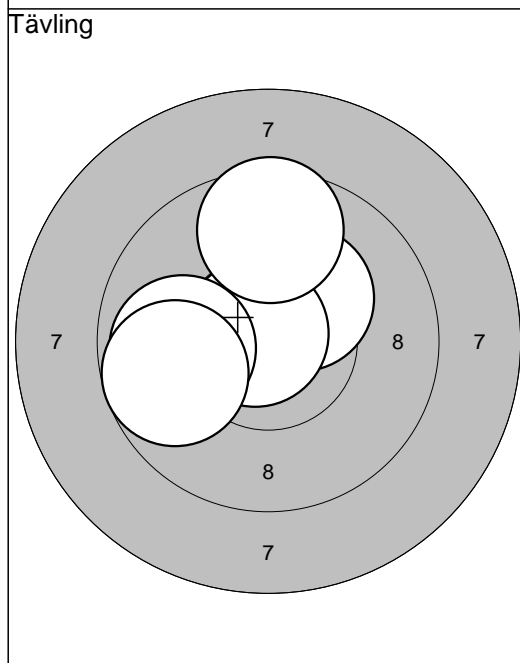

6: 10,3*	↗
7: 10,8*	↖
8: 9,9	←
9: 9,8	←
10: 9,6	↑
Serie: 50,4	
Summa: 101,2	

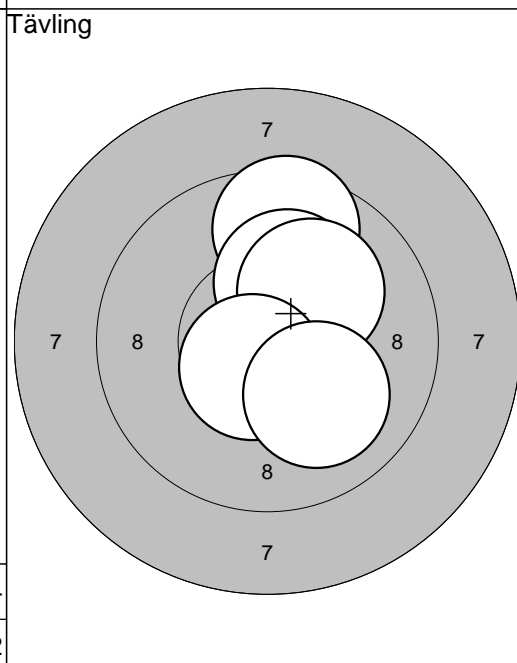

11: 9,6	↑
12: 10,2*	↗
13: 10,1	↗
14: 10,6*	↘
15: 10,1	↘
Serie: 50,6	
Summa: 151,8	

Tävling

16: 10,5*	→
17: 10,4*	↙
18: 10,4*	↖
19: 10,5*	↙
20: 10,2*	↓
<b>Serie: 52,0</b>	
<b>Summa: 203,8</b>	

Tävling

21: 9,6	↖
22: 10,7*	→
23: 10,6*	↗
24: 10,6*	↓
25: 10,6*	↙
<b>Serie: 52,1</b>	
<b>Summa: 255,9</b>	

Tävling

26: 10,4*	↘
27: 9,5	↑
28: 10,2*	↑
29: 10,3*	↗
30: 10,7*	←
<b>Serie: 51,1</b>	
<b>Summa: 307,0</b>	

Tävling

31: 10,3*	↖
32: 10,1	↙
33: 10,3*	↖
34: 10,5*	↘
35: 10,2*	↖
<b>Serie: 51,4</b>	
<b>Summa: 358,4</b>	

Tävling

36: 10,1	↗
37: 10,4*	↑
38: 10,5*	↗
39: 10,2*	↘
40: 10,3*	↓
<b>Serie: 51,5</b>	
<b>Summa: 409,9</b>	

<b>Serie: 51,5</b>	
<b>Summa: 409,9</b>	

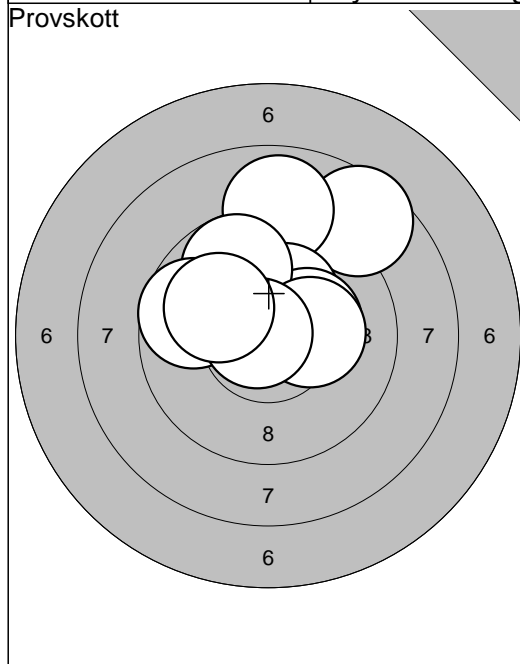

1: 8,6	↗
2: 8,9	↑
3: 10,3*	↗
4: 10,3*	→
5: 10,5*	↗
6: 9,8	↗
7: 9,7	←
8: 10,3*	→
9: 10,8*	←
10: 10,0	↖
<b>Serie: 99,2</b>	
<b>Summa: 0,0</b>	

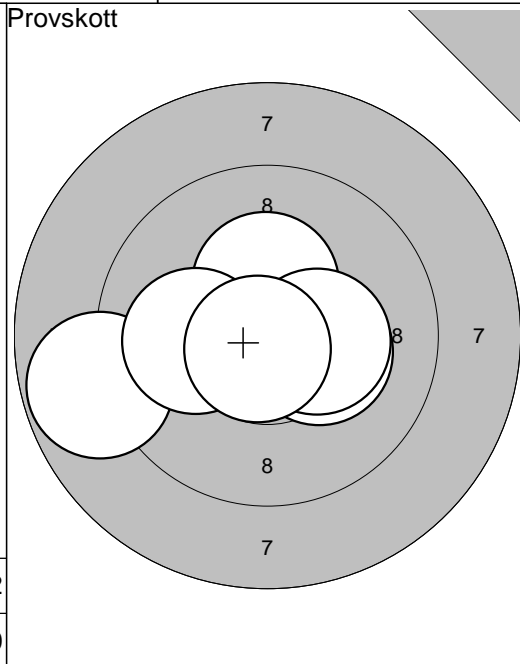

11: 10,3*	→
12: 8,8	←
13: 10,3*	↑
14: 10,1	←
15: 10,3*	→
16: 10,7*	↘
<b>Serie: 60,5</b>	
<b>Summa: 0,0</b>	

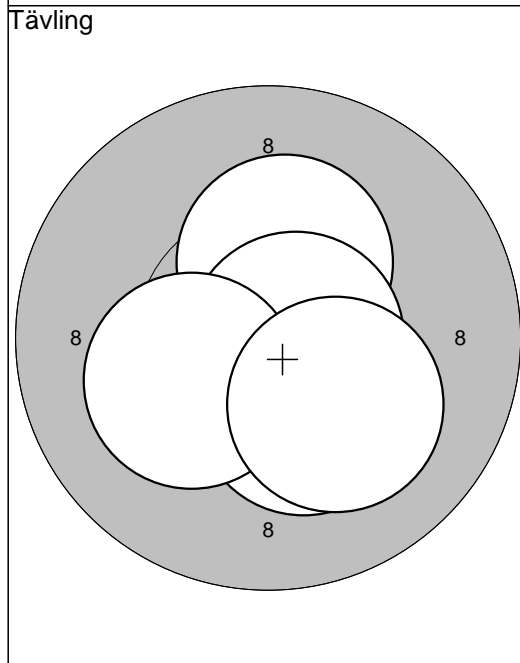

1: 10,3*	↘
2: 10,3*	↑
3: 10,7*	→
4: 10,2*	↙
5: 10,2*	↘
<b>Serie: 51,7</b>	
<b>Summa: 51,7</b>	

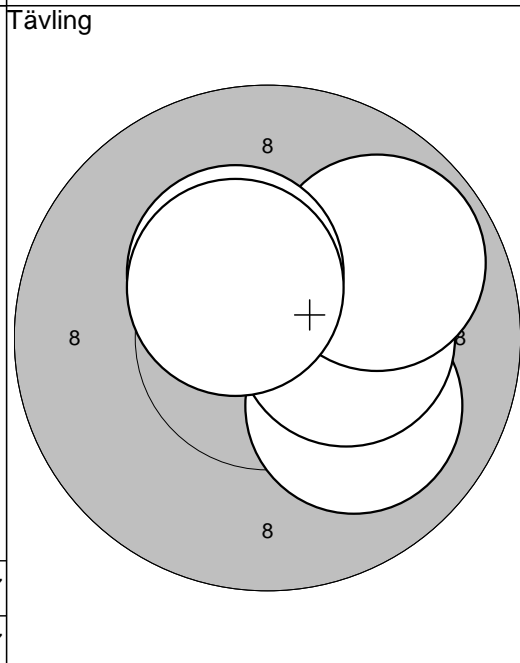

6: 10,0	↘
7: 10,3*	→
8: 9,8	↗
9: 10,4*	↗
10: 10,5*	↗
<b>Serie: 51,0</b>	
<b>Summa: 102,7</b>	

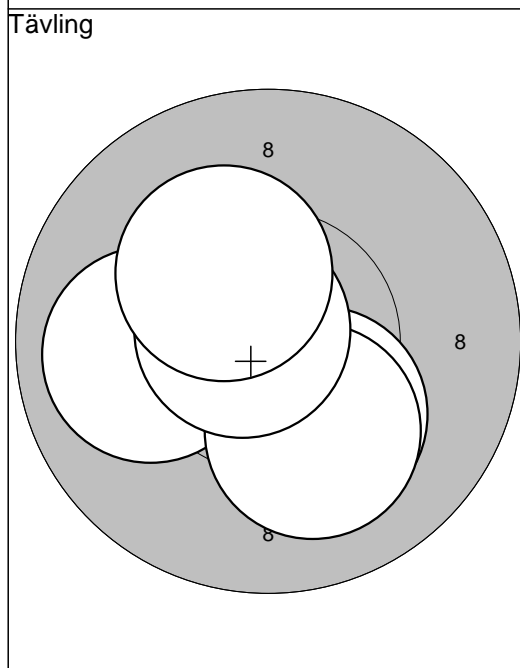

11: 10,0	←
12: 10,2*	↘
13: 10,1	↘
14: 10,7*	↗
15: 10,3*	↗
<b>Serie: 51,3</b>	
<b>Summa: 154,0</b>	

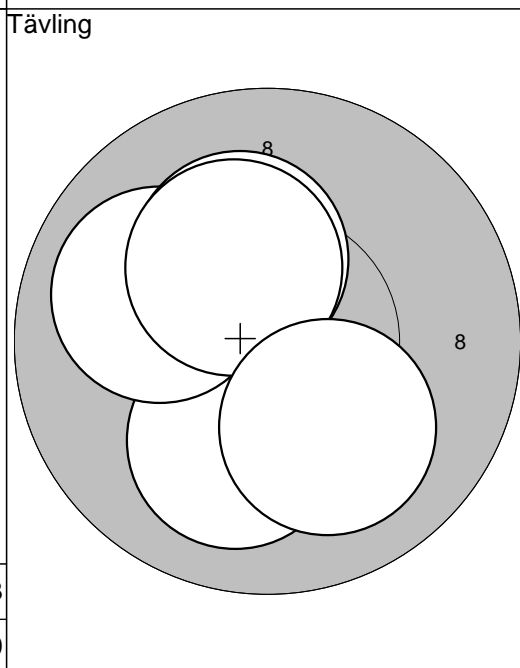

16: 10,1	↘
17: 10,0	←
18: 10,2*	↗
19: 10,3*	↗
20: 10,1	↘
<b>Serie: 50,7</b>	
<b>Summa: 204,7</b>	

Tävling

21: 10,5*	↗
22: 10,0	↘
23: 10,4*	↖
24: 10,6*	→
25: 9,9	↖
Serie: 51,4	
Summa: 256,1	

Tävling

26: 10,6*	↘
27: 10,5*	←
28: 10,1	↖
29: 10,5*	↘
30: 10,4*	↗
Serie: 52,1	
Summa: 308,2	

Tävling

31: 10,9*	↘
32: 9,7	↘
33: 10,3*	→
34: 10,3*	↖
35: 10,1	↗
Serie: 51,3	
Summa: 359,5	

Tävling

36: 9,7	↖
37: 10,7*	↖
38: 10,4*	↖
39: 10,7*	↗
40: 10,2*	↖
Serie: 51,7	
Summa: 411,2	

--	--

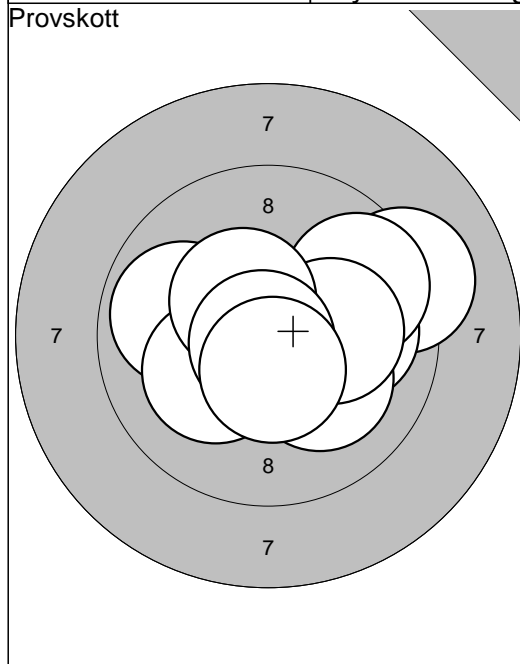

1: 9,2	➔
2: 10,0	➔
3: 10,1	↘
4: 9,7	➔
5: 9,9	↙
6: 10,2*	➔
7: 10,2*	↙
8: 10,4*	↗
9: 10,8*	↘
10: 10,5*	↓
<b>Serie: 101,0</b>	
<b>Summa: 0,0</b>	

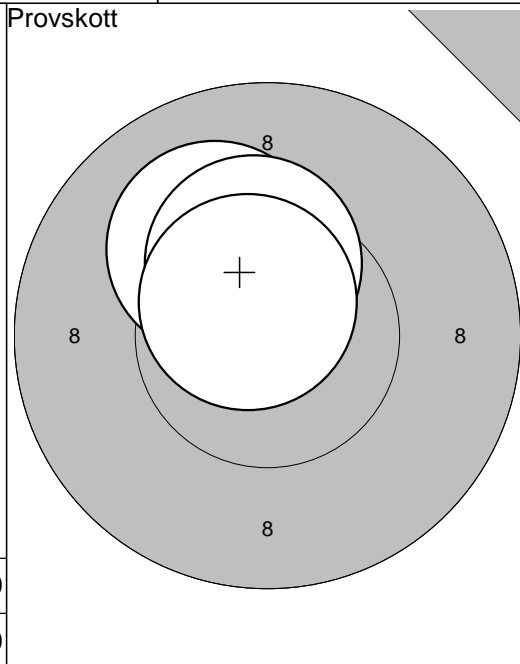

11: 10,1	↗
12: 10,3*	↑
13: 10,6*	↗
<b>Serie: 31,0</b>	
<b>Summa: 0,0</b>	

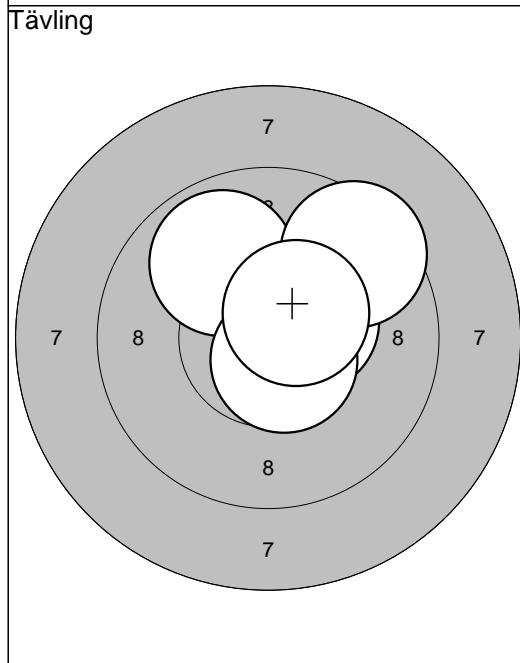

1: 9,9	↖
2: 10,4*	➔
3: 10,6*	↘
4: 9,5	↗
5: 10,5*	↗
<b>Serie: 50,9</b>	
<b>Summa: 50,9</b>	

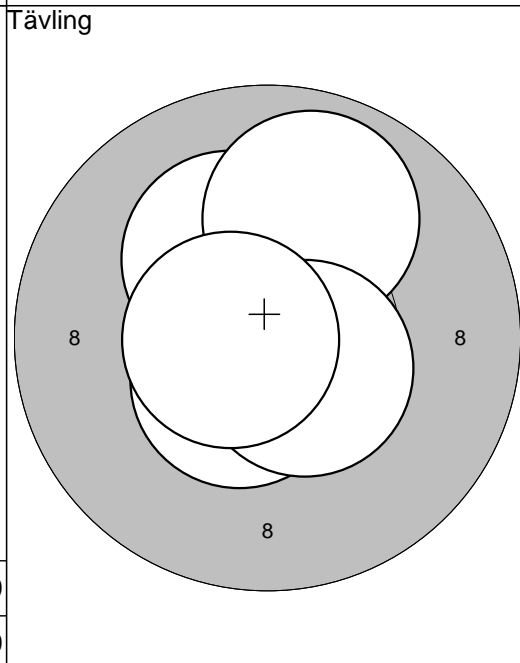

6: 10,2*	↖
7: 9,9	↑
8: 10,5*	↘
9: 10,5*	↘
10: 10,7*	←
<b>Serie: 51,8</b>	
<b>Summa: 102,7</b>	

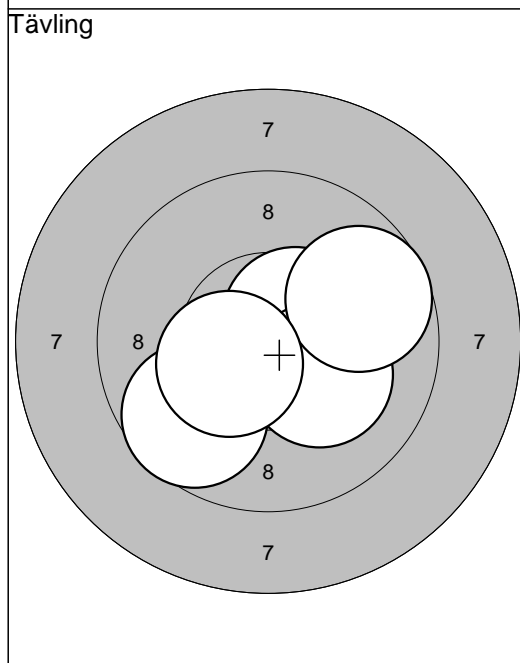

11: 10,5*	↗
12: 9,7	↘
13: 10,2*	↘
14: 9,7	➔
15: 10,4*	↙
<b>Serie: 50,5</b>	
<b>Summa: 153,2</b>	

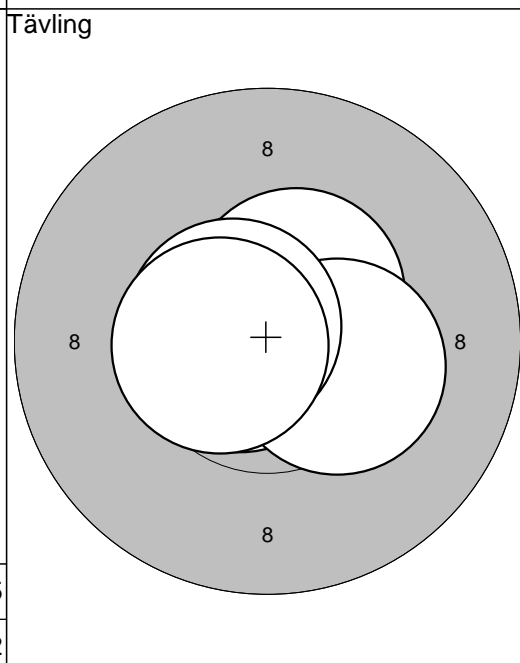

16: 10,5*	↗
17: 10,7*	←
18: 10,3*	➔
19: 10,6*	↙
20: 10,6*	←
<b>Serie: 52,7</b>	
<b>Summa: 205,9</b>	



Tävling

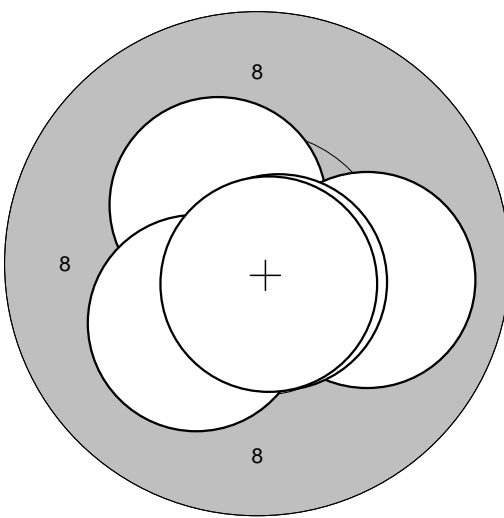

Serie:	52,1
Summa:	258,0

21: 10,4\* ↗  
 22: 10,2\* ↙  
 23: 10,0 →  
 24: 10,7\* ↙  
 25: 10,8\* ↙

Tävling

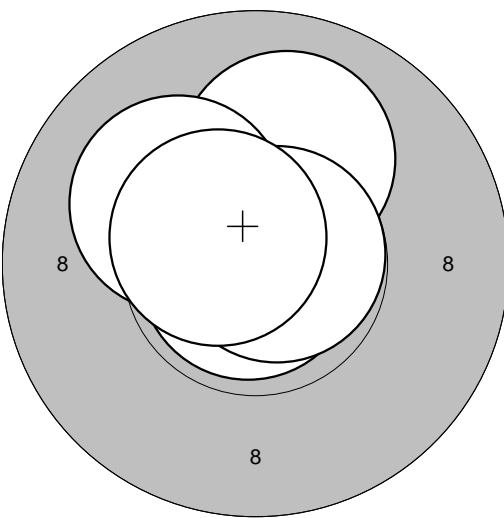

Serie:	52,4
Summa:	310,4

26: 10,0 ↑  
 27: 10,9\* ↙  
 28: 10,8\* →  
 29: 10,1 ↖  
 30: 10,6\* ↖

Tävling

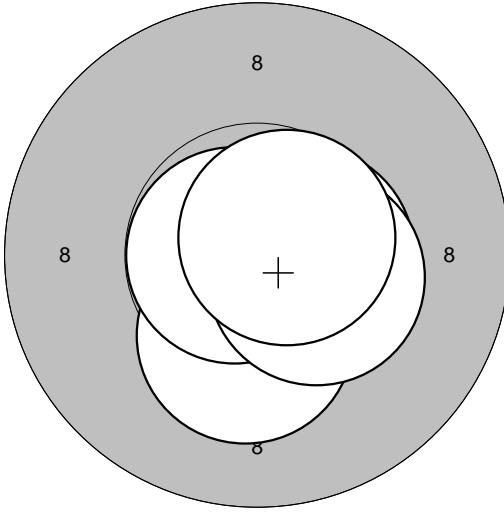

Serie:	52,7
Summa:	363,1

31: 10,5\* →  
 32: 10,3\* ↓  
 33: 10,8\* ←  
 34: 10,4\* →  
 35: 10,7\* →

Tävling

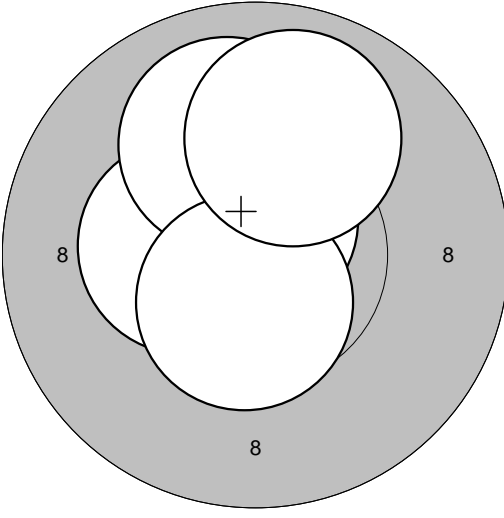

Serie:	51,5
Summa:	414,6

36: 10,7\* ↑  
 37: 10,4\* ←  
 38: 10,0 ↑  
 39: 10,5\* ↓  
 40: 9,9 ↑

--	--

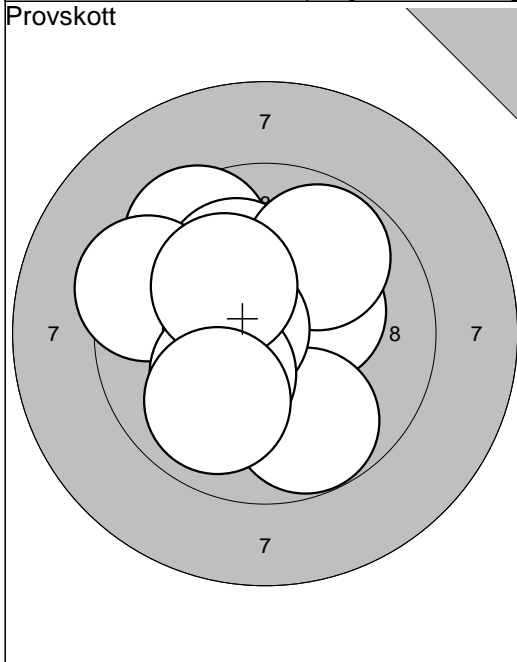

1: 10,3*	↗
2: 9,5	↗
3: 10,1	↗
4: 9,8	↗
5: 9,8	↘
6: 9,4	↖
7: 10,6*	↖
8: 10,2*	↘
9: 10,2*	↗
10: 9,9	↘
<b>Serie: 99,8</b>	
<b>Summa: 0,0</b>	

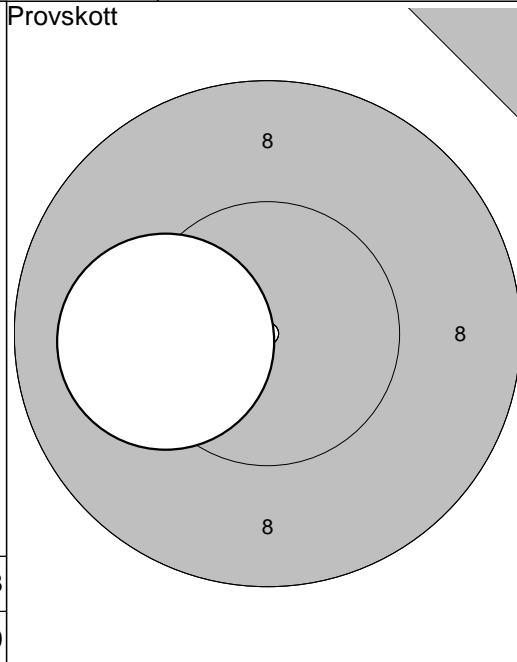

11: 10,1	↖
<b>Serie: 10,1</b>	
<b>Summa: 0,0</b>	

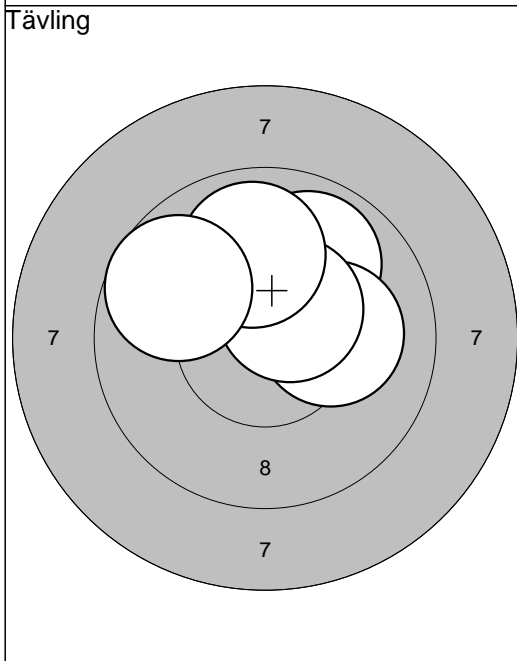

1: 9,9	↗
2: 10,1	→
3: 10,5*	↗
4: 9,9	↑
5: 9,7	↖
<b>Serie: 50,1</b>	
<b>Summa: 50,1</b>	

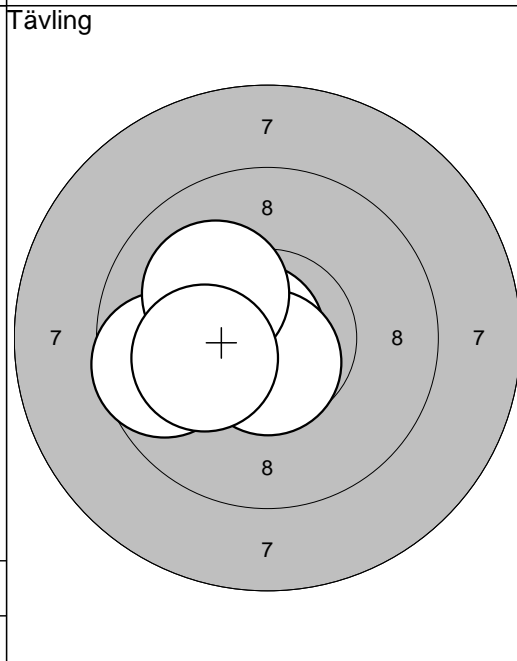

6: 10,8*	↖
7: 10,7*	↓
8: 9,7	↖
9: 10,1	↗
10: 10,1	↖
<b>Serie: 51,4</b>	
<b>Summa: 101,5</b>	

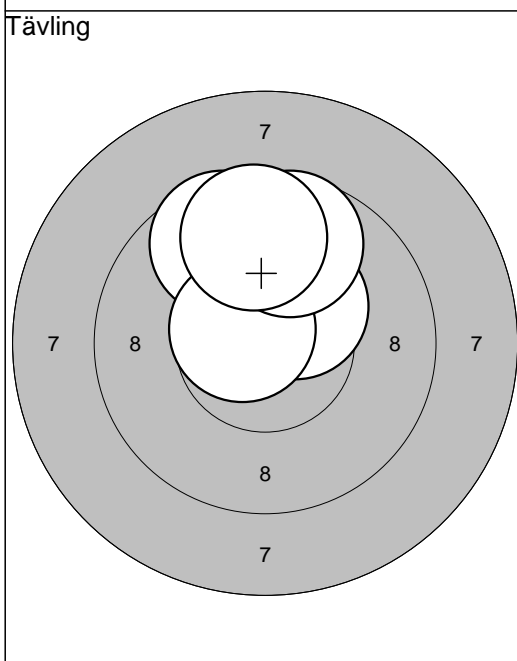

11: 9,6	↖
12: 10,4*	↗
13: 10,6*	↖
14: 9,7	↑
15: 9,7	↑
<b>Serie: 50,0</b>	
<b>Summa: 151,5</b>	

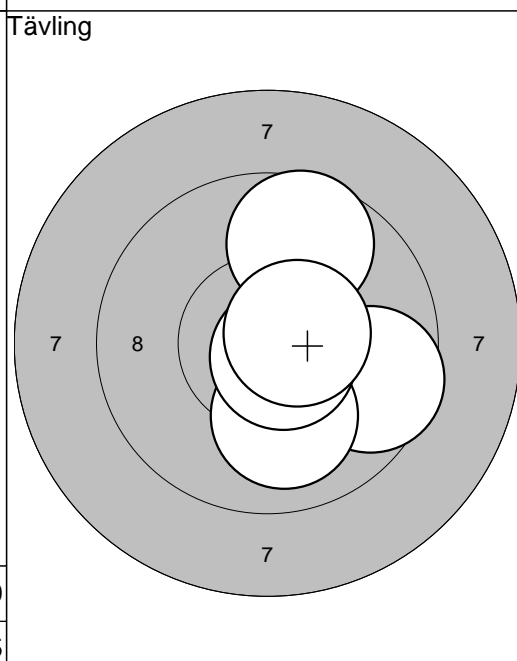

16: 9,7	↗
17: 9,6	→
18: 10,0	↓
19: 10,7*	↘
20: 10,6*	→
<b>Serie: 50,6</b>	
<b>Summa: 202,1</b>	

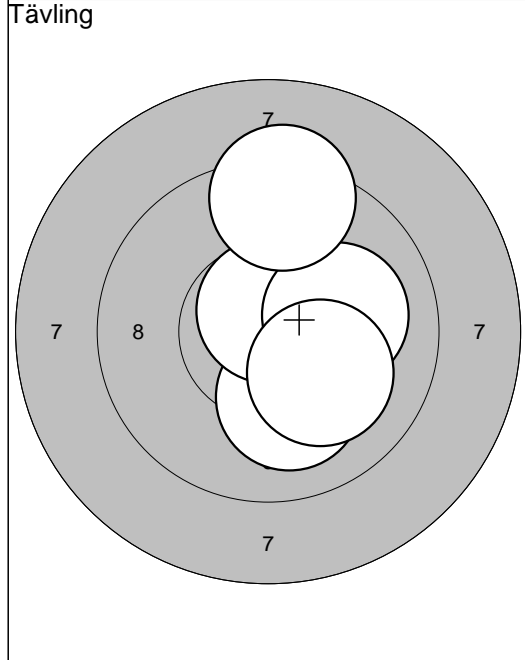

21: 10,1	↘
22: 10,7*	↑
23: 10,1	→
24: 9,3	↑
25: 10,1	↘
Serie:	50,3
Summa:	252,4

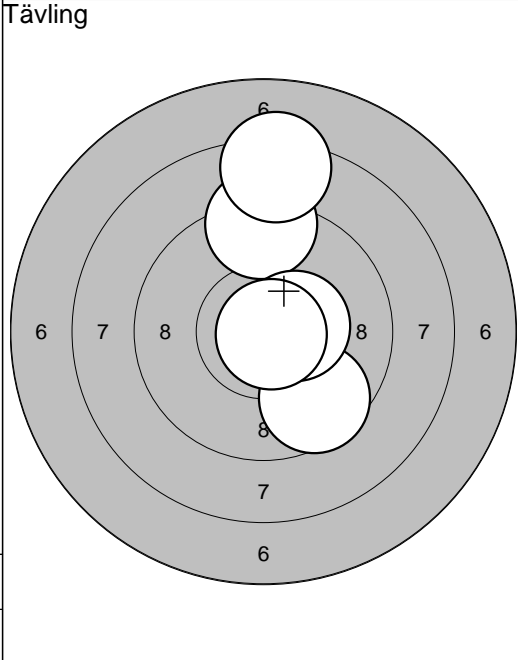

26: 9,6	↘
27: 9,2	↑
28: 10,4*	→
29: 10,8*	↘
30: 8,3	↑
Serie:	48,3
Summa:	300,7

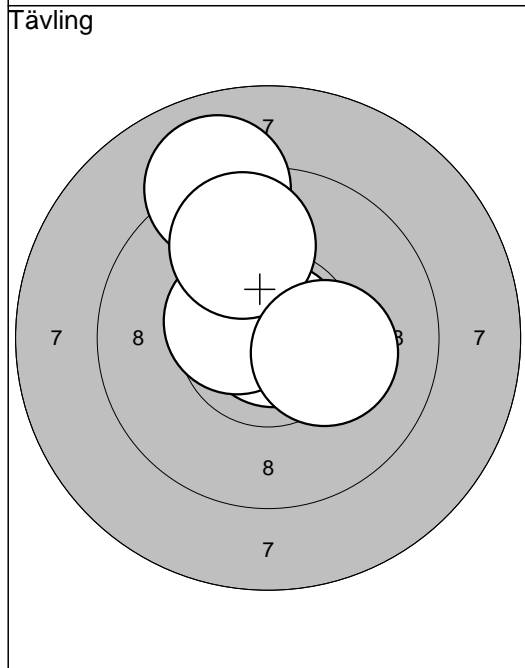

31: 9,0	↑
32: 10,9*	↗
33: 10,5*	↖
34: 9,8	↑
35: 10,2*	↘
Serie:	50,4
Summa:	351,1

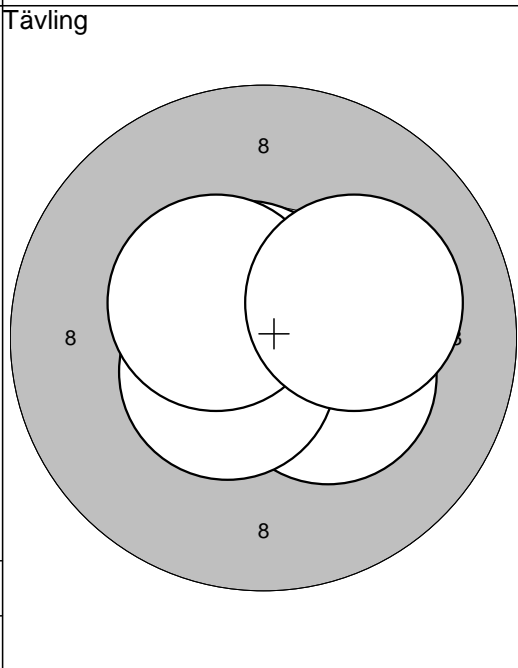

36: 10,7*	↖
37: 10,3*	↘
38: 10,5*	↙
39: 10,5*	↖
40: 10,1	↗
Serie:	52,1
Summa:	403,2

--	--

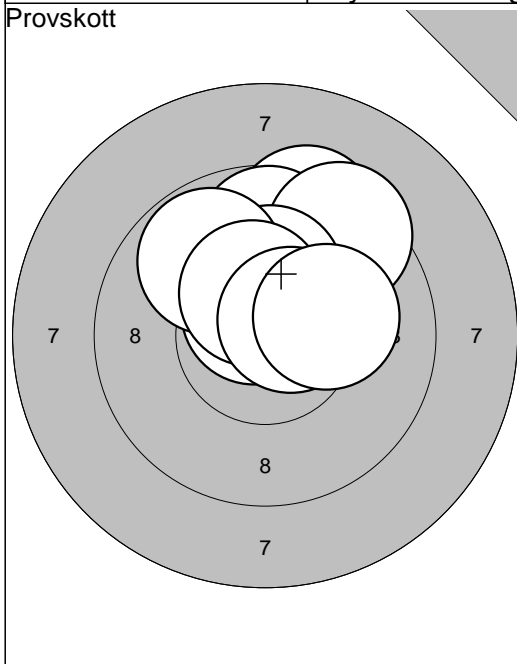

1: 9,4	↗
2: 9,9	↗
3: 9,8	↑
4: 10,6*	↖
5: 9,4	↗
6: 10,3*	↑
7: 9,8	↖
8: 10,4*	↑
9: 10,6*	↗
10: 10,2*	→
<b>Serie: 100,4</b>	
<b>Summa: 0,0</b>	

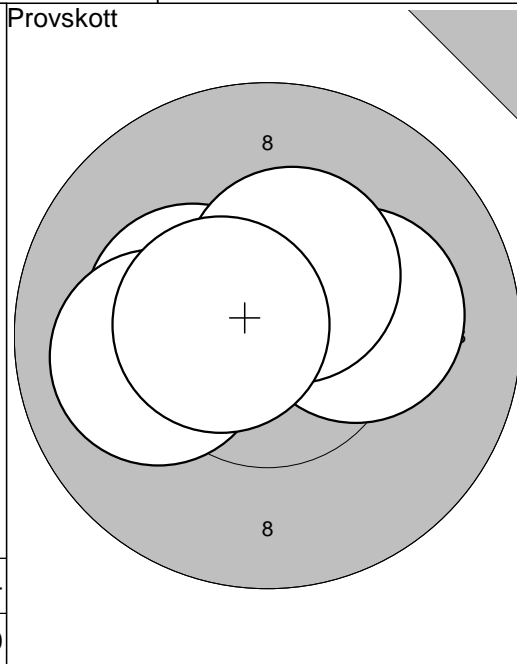

11: 10,3*	↖
12: 10,0	↖
13: 10,2*	→
14: 10,4*	↗
15: 10,6*	↖
<b>Serie: 51,5</b>	
<b>Summa: 0,0</b>	

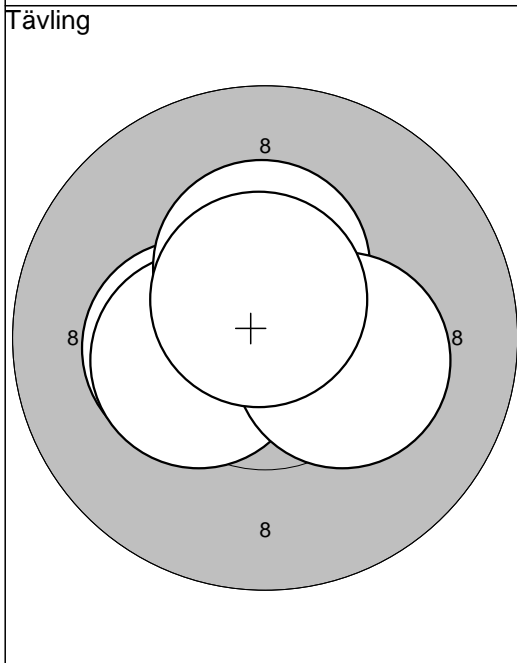

1: 10,3*	↖
2: 10,4*	↖
3: 10,4*	↑
4: 10,3*	→
5: 10,6*	↑
<b>Serie: 52,0</b>	
<b>Summa: 52,0</b>	

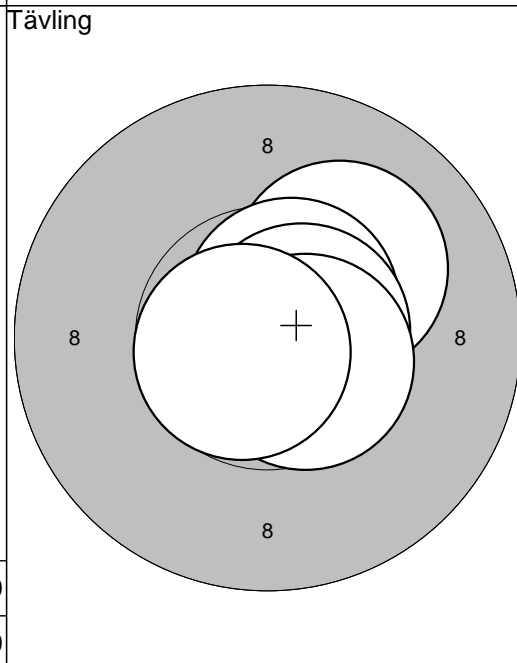

6: 10,1	↗
7: 10,6*	↗
8: 10,7*	→
9: 10,6*	↘
10: 10,7*	↖
<b>Serie: 52,7</b>	
<b>Summa: 104,7</b>	

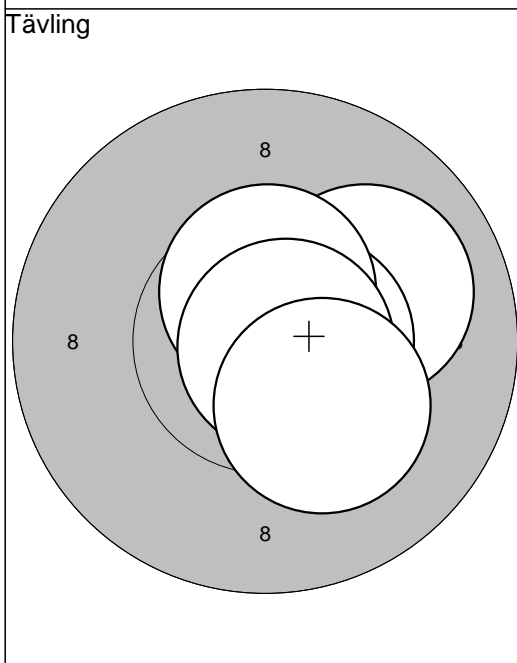

11: 10,0	↗
12: 10,6*	→
13: 10,5*	↑
14: 10,8*	→
15: 10,2*	↘
<b>Serie: 52,1</b>	
<b>Summa: 156,8</b>	

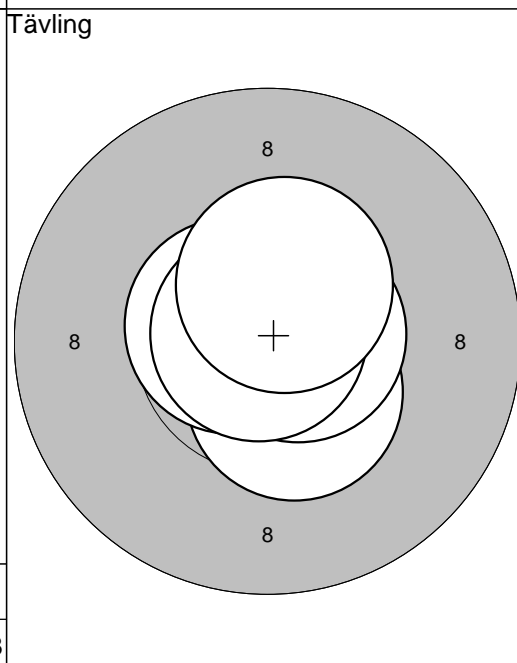

16: 10,5*	↘
17: 10,6*	↖
18: 10,7*	→
19: 10,9*	↖
20: 10,5*	↑
<b>Serie: 53,2</b>	
<b>Summa: 210,0</b>	

Tävling

21: 10,3\* ↗  
 22: 10,4\* ↘  
 23: 10,2\* →  
 24: 9,8 →  
 25: 10,7\* ↓

---

Serie: 51,4  
 Summa: 261,4

Tävling

26: 10,4\* ↗  
 27: 10,7\* ↑  
 28: 10,4\* →  
 29: 10,4\* ↑  
 30: 10,6\* →

---

Serie: 52,5  
 Summa: 313,9

Tävling

31: 10,8\* →  
 32: 10,7\* ←  
 33: 10,8\* ↓  
 34: 10,1 ↗  
 35: 10,3\* ↑

---

Serie: 52,7  
 Summa: 366,6

Tävling

36: 10,5\* →  
 37: 10,7\* ↓  
 38: 10,6\* ↓  
 39: 10,5\* ↗  
 40: 10,1 ↑

---

Serie: 52,4  
 Summa: 419,0

--	--

Provskott

1: 10,6*	↑
2: 10,4*	↙
3: 10,1	↓
4: 10,5*	↙
5: 10,6*	↘
6: 10,5*	↓
7: 10,8*	↓
8: 10,2*	↘
9: 10,5*	↙
<hr/>	
Serie:	94,2
Summa:	0,0

Tävling

1: 10,1	↘
2: 10,3*	↙
3: 10,6*	↙
4: 10,6*	↓
5: 10,4*	↙
<hr/>	
Serie:	52,0
Summa:	52,0

Tävling

6: 10,2*	↖
7: 10,0	↖
8: 10,0	↗
9: 10,1	↑
10: 10,5*	→
<hr/>	
Serie:	50,8
Summa:	102,8

Tävling

11: 10,1	↗
12: 10,5*	↑
13: 10,5*	↘
14: 10,5*	↓
15: 10,2*	↗
<hr/>	
Serie:	51,8
Summa:	154,6

Tävling

16: 10,7*	↑
17: 10,6*	↗
18: 10,4*	↗
19: 10,5*	↘
20: 10,2*	↖
<hr/>	
Serie:	52,4
Summa:	207,0

Tävling

21: 10,6*	↗
22: 10,5*	↙
23: 10,6*	↙
24: 10,5*	↘
25: 10,5*	→
<hr/>	
Serie:	52,7
Summa:	259,7

Tävling

26: 10,2*	↖
27: 10,3*	↖
28: 10,5*	↑
29: 10,1	↗
30: 10,6*	↖
<hr/>	
Serie:	51,7
Summa:	311,4

Tävling

31: 10,3*	↑
32: 10,4*	↗
33: 10,0	↗
34: 10,8*	↗
35: 10,5*	↖
<hr/>	
Serie:	52,0
Summa:	363,4

Tävling

36: 10,5*	↑
37: 10,3*	↖
38: 10,6*	↙
39: 10,2*	↖
40: 10,3*	↑
<hr/>	
Serie:	51,9
Summa:	415,3

--	--

Provskott

1: 10,6*	↘
2: 10,5*	↗
3: 10,8*	←
4: 10,4*	↓
5: 10,5*	↑
6: 10,1	↓
7: 10,5*	↗
8: 10,8*	←
9: 10,4*	↑
10: 10,4*	↖
Serie: 105,0	
Summa: 0,0	

Provskott

11: 10,5*	↑
12: 10,6*	↑
13: 10,3*	←
14: 10,5*	↑
15: 10,7*	←
16: 10,6*	↙
17: 10,7*	↙
18: 10,7*	↓
Serie: 84,6	
Summa: 0,0	

Tävling

1: 10,5*	↗
2: 10,1	↑
3: 10,3*	↑
4: 10,8*	↖
5: 10,7*	↗
Serie: 52,4	
Summa: 52,4	

Tävling

6: 10,4*	↖
7: 10,6*	↓
8: 10,5*	←
9: 10,3*	↙
10: 10,4*	↙
Serie: 52,2	
Summa: 104,6	

Tävling

11: 10,6*	↓
12: 10,3*	↓
13: 10,6*	↑
14: 10,4*	←
15: 10,6*	↗
Serie: 52,5	
Summa: 157,1	

Tävling

16: 10,7*	↗
17: 10,1	↗
18: 10,0	↓
19: 10,3*	↙
20: 10,7*	↑
Serie: 51,8	
Summa: 208,9	



**Tävling**

21: 9,7	↓
22: 10,7*	↙
23: 10,7*	↘
24: 10,2*	↘
25: 10,3*	↙
<b>Serie: 51,6</b>	
<b>Summa: 260,5</b>	

**Tävling**

26: 10,2*	↑
27: 10,0	↘
28: 10,8*	↘
29: 10,4*	→
30: 10,3*	↗
<b>Serie: 51,7</b>	
<b>Summa: 312,2</b>	

**Tävling**

31: 10,2*	↗
32: 9,4	↑
33: 10,1	↑
34: 10,8*	↙
35: 10,0	↑
<b>Serie: 50,5</b>	
<b>Summa: 362,7</b>	

**Tävling**

36: 10,5*	↙
37: 10,5*	←
38: 10,5*	↑
39: 10,6*	↘
40: 10,7*	←
<b>Serie: 52,8</b>	
<b>Summa: 415,5</b>	

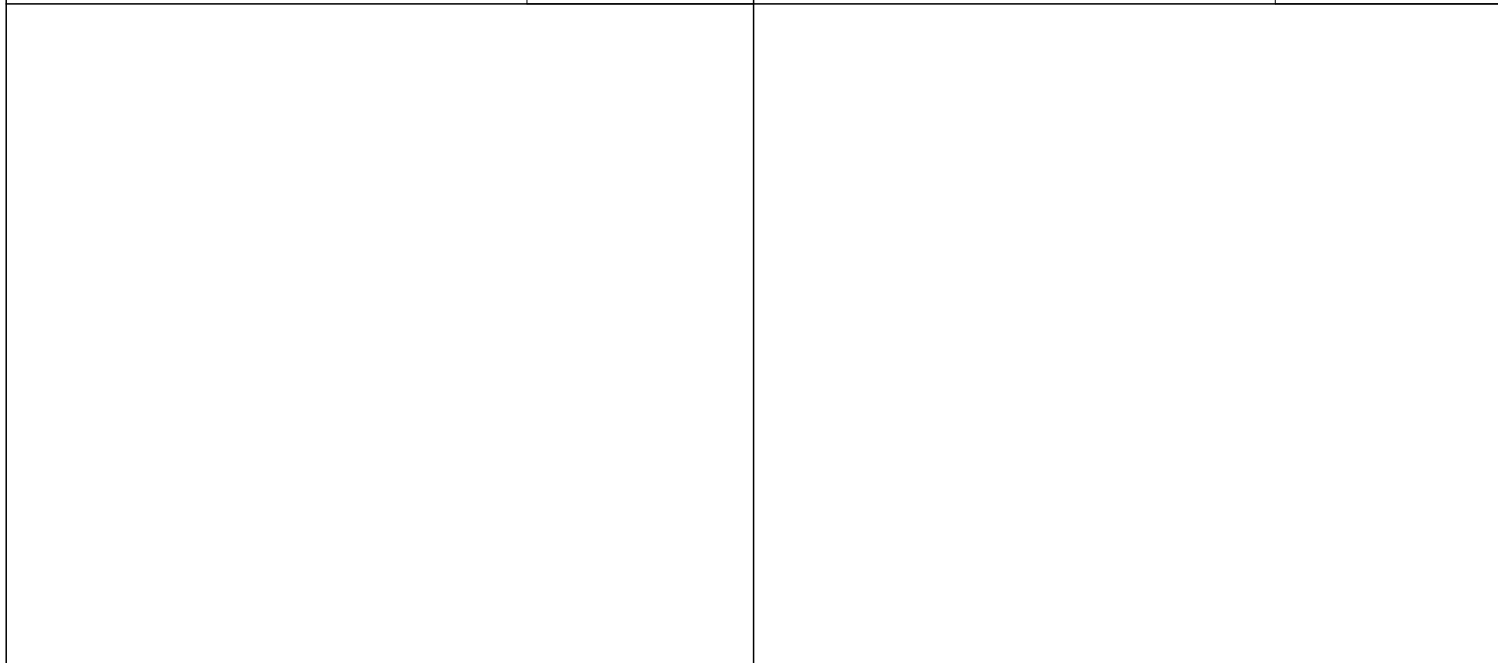

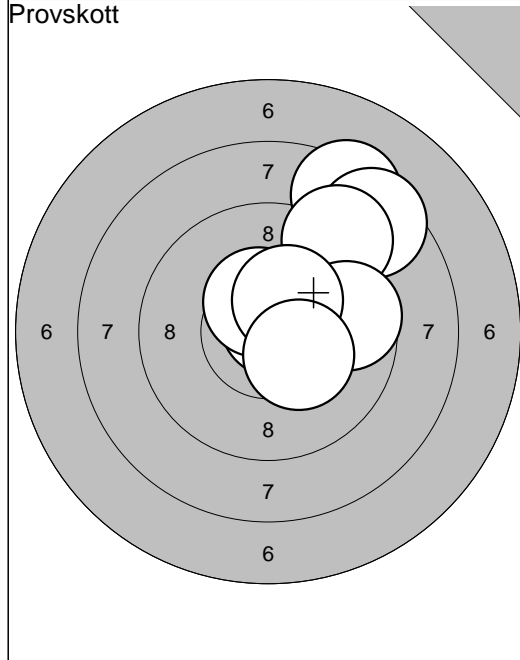

1: 8,4	↗
2: 8,5	↗
3: 9,1	↗
4: 10,5*	→
5: 10,7*	↗
6: 10,2*	→
7: 9,6	→
8: 10,5*	↑
9: 10,4*	↗
10: 10,3*	↘
Serie: 98,2	
Summa: 0,0	

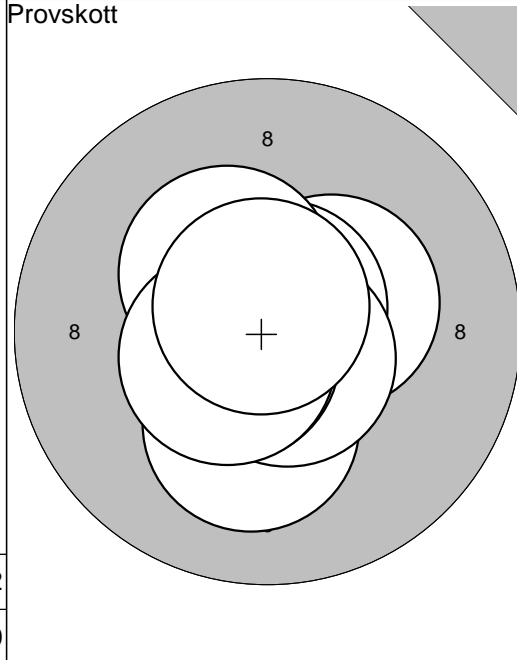

11: 10,2*	↓
12: 10,4*	→
13: 10,8*	↑
14: 10,7*	↙
15: 10,7*	↗
16: 10,7*	↘
17: 10,4*	↗
18: 10,6*	↙
19: 10,6*	↙
20: 10,7*	↑
Serie: 105,8	
Summa: 0,0	

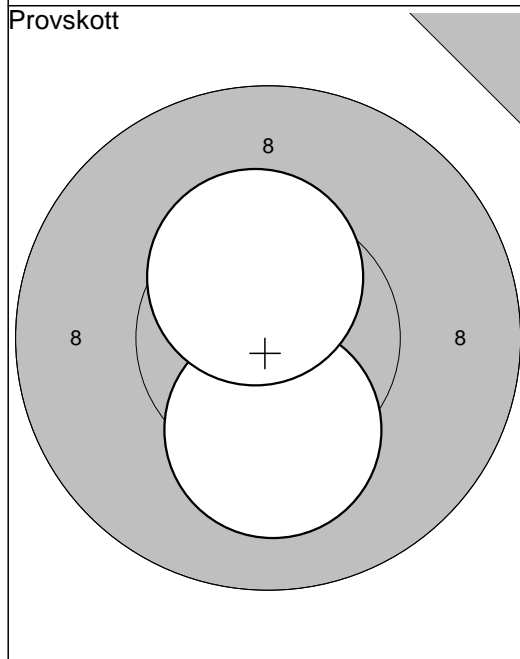

21: 10,2*	↓
22: 10,4*	↑
Serie: 20,6	
Summa: 0,0	

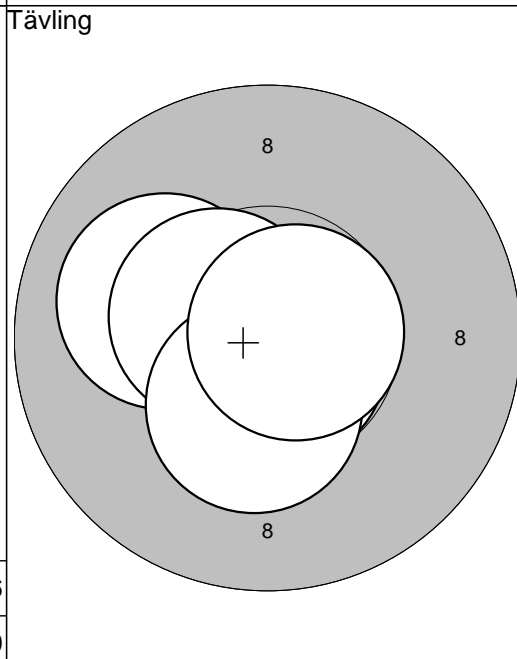

1: 10,1	↙
2: 10,8*	↘
3: 10,5*	↙
4: 10,4*	↓
5: 10,7*	→
Serie: 52,5	
Summa: 52,5	

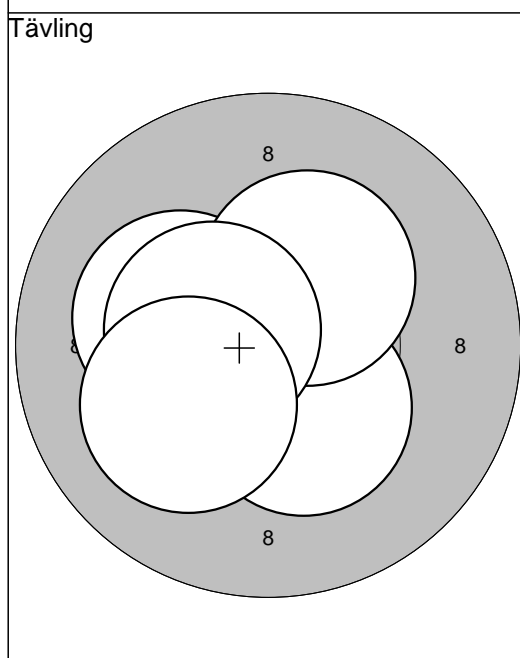

6: 10,2*	↙
7: 10,3*	↘
8: 10,3*	↗
9: 10,5*	↙
10: 10,1	↙
Serie: 51,4	
Summa: 103,9	

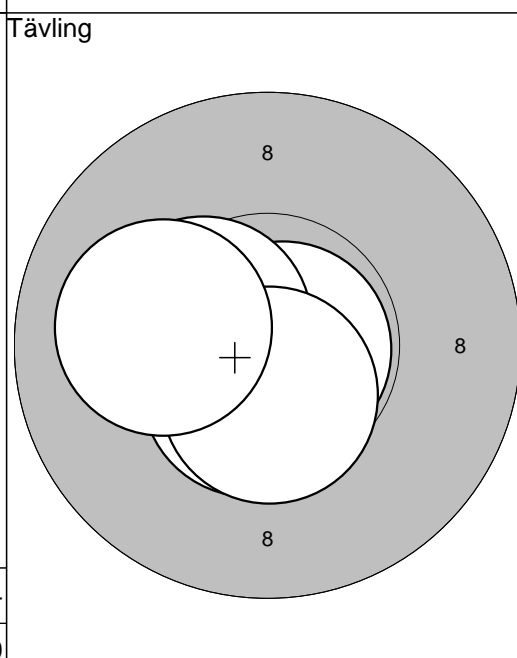

11: 10,8*	→
12: 10,6*	↘
13: 10,4*	↙
14: 10,5*	↓
15: 10,1	↙
Serie: 52,4	
Summa: 156,3	

Tävling

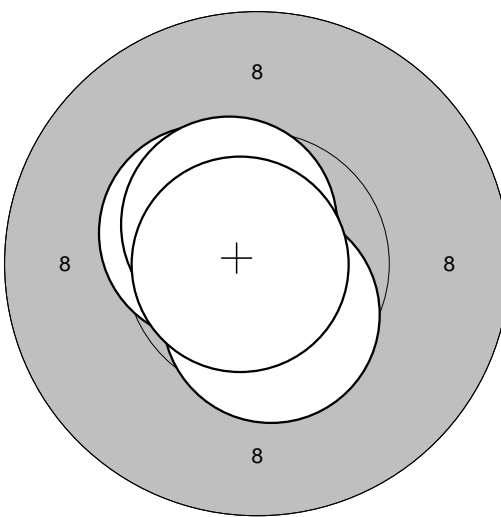

8  
8  
8  
8

16: 10,5*	↓
17: 10,7*	↖
18: 10,5*	↖
19: 10,6*	↗
20: 10,8*	←
Serie: 53,1	
Summa: 209,4	

Tävling

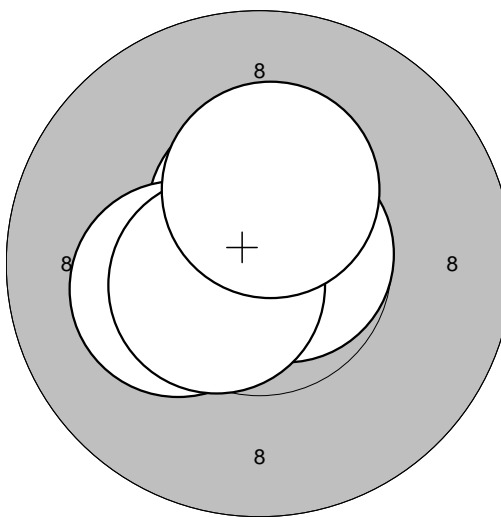

8  
8  
8  
8

21: 10,5*	↑
22: 10,7*	→
23: 10,2*	←
24: 10,6*	↙
25: 10,3*	↑
Serie: 52,3	
Summa: 261,7	

Tävling

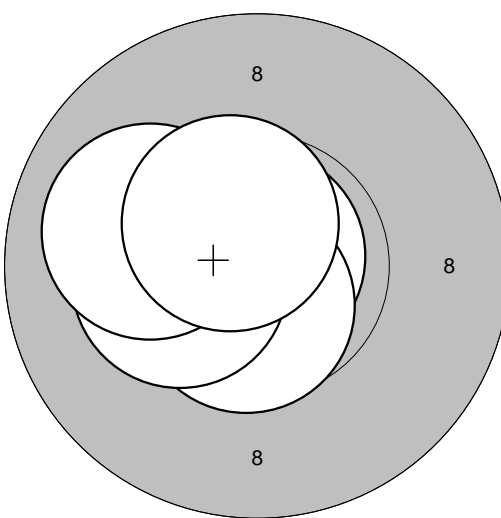

8  
8  
8  
8

26: 10,9*	↑
27: 10,6*	↓
28: 10,3*	←
29: 10,0	↙
30: 10,5*	↗
Serie: 52,3	
Summa: 314,0	

Tävling

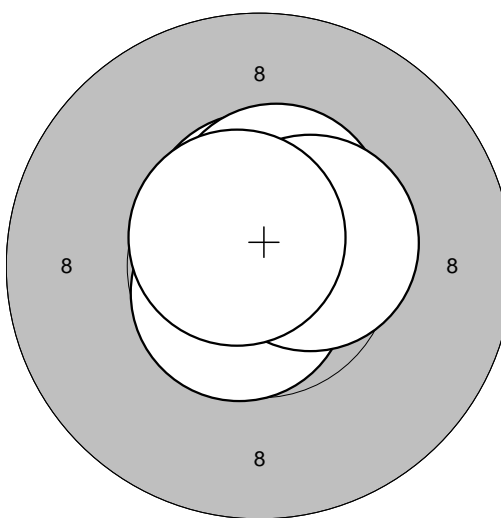

8  
8  
8  
8

31: 10,7*	↘
32: 10,6*	↑
33: 10,5*	↑
34: 10,5*	→
35: 10,7*	↖
Serie: 53,0	
Summa: 367,0	

Tävling

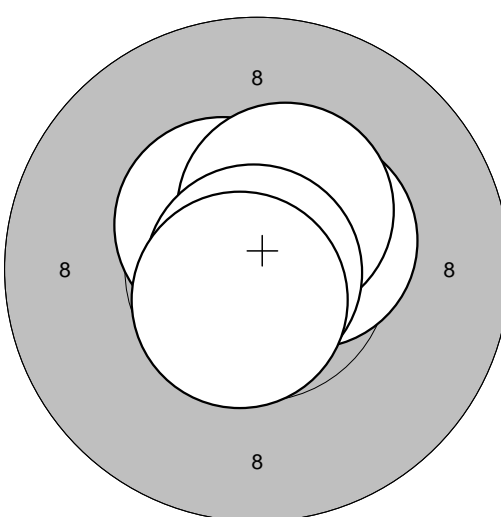

8  
8  
8  
8

36: 10,5*	↗
37: 10,5*	↖
38: 10,4*	↗
39: 10,9*	↘
40: 10,7*	↘
Serie: 53,0	
Summa: 420,0	

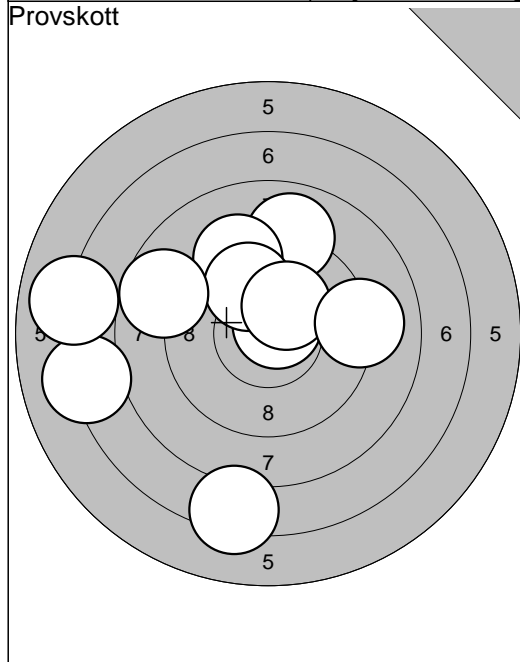

1: 7,2	←
2: 7,3	↓
3: 7,0	←
4: 9,0	↑
5: 10,7*	↗
6: 9,3	↗
7: 9,9	↗
8: 8,7	←
9: 10,3*	↗
10: 9,1	→
Serie:	88,5
Summa:	0,0

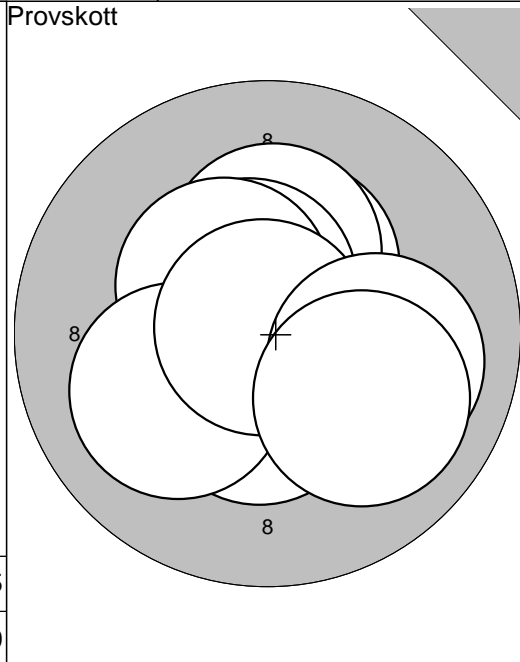

11: 10,6*	↓
12: 10,4*	↗
13: 10,3*	↑
14: 10,5*	↗
15: 10,4*	↗
16: 10,4*	↓
17: 10,1	↙
18: 10,9*	↗
19: 10,0	→
20: 10,0	↘
Serie:	103,6
Summa:	0,0

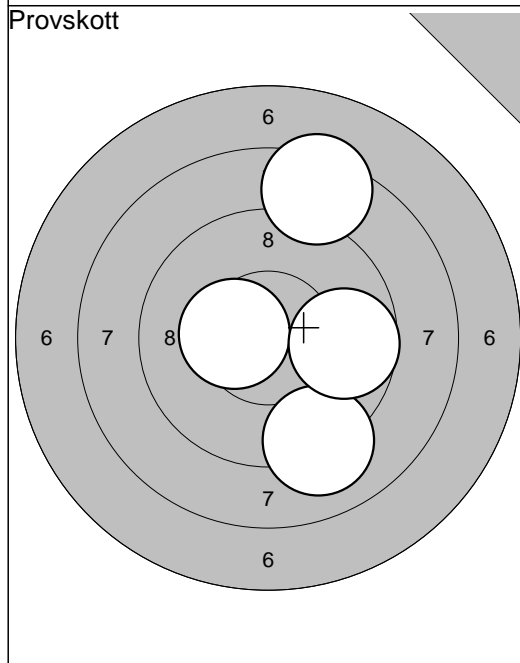

21: 8,4	↗
22: 9,1	↓
23: 10,4*	←
24: 9,7	→
Serie:	37,6
Summa:	0,0

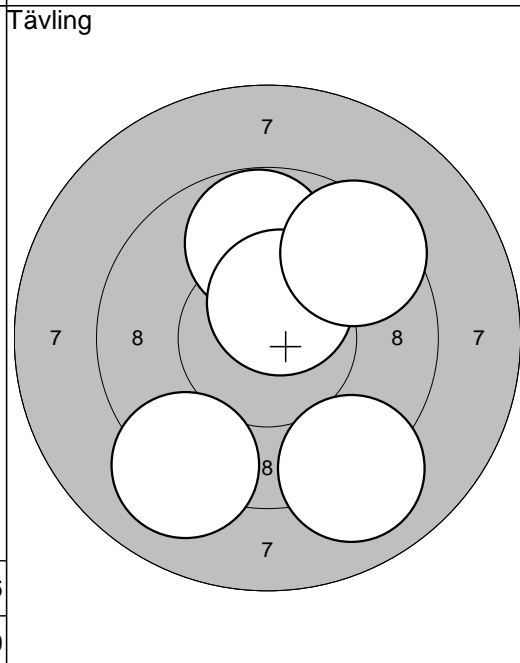

1: 9,8	↑
2: 10,5*	↗
3: 9,1	↙
4: 9,5	↗
5: 9,0	↓
Serie:	47,9
Summa:	47,9

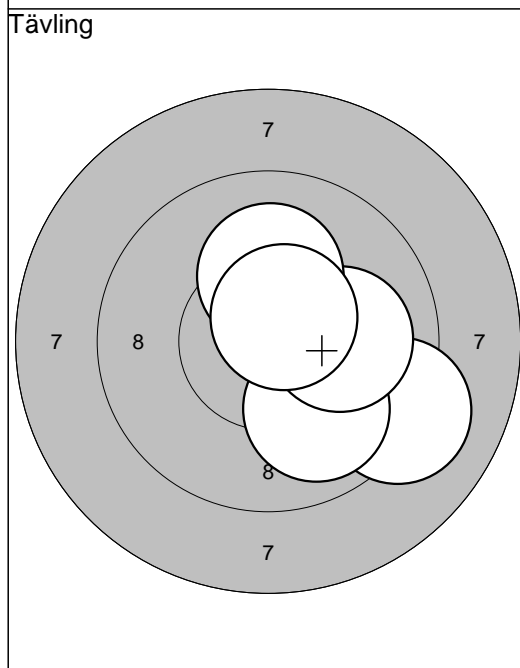

6: 9,1	↘
7: 9,9	↘
8: 10,1	→
9: 10,2*	↑
10: 10,6*	↗
Serie:	49,9
Summa:	97,8

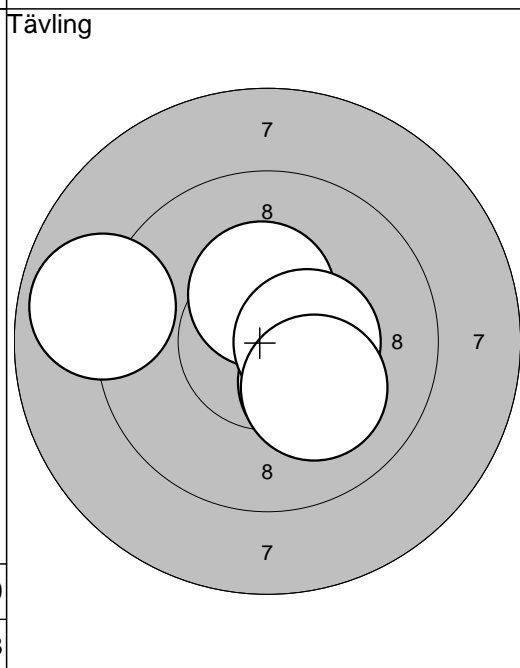

11: 8,9	←
12: 10,4*	↑
13: 10,2*	↘
14: 10,5*	→
15: 10,1	↘
Serie:	50,1
Summa:	147,9

Tävling

7  
8 8 7  
7

16: 10,1	↑
17: 10,6*	→
18: 10,0	↑
19: 9,7	↗
20: 10,1	↓
<hr/>	
Serie:	50,5
Summa:	198,4

Tävling

7  
8 7  
8 7  
7

21: 10,2*	↗
22: 10,1	↘
23: 9,8	→
24: 9,2	←
25: 10,1	→
<hr/>	
Serie:	49,4
Summa:	247,8

Tävling

7  
8 8 7  
8 7  
7

26: 9,4	←
27: 10,4*	↗
28: 10,2*	↖
29: 10,3*	↑
30: 10,3*	←
<hr/>	
Serie:	50,6
Summa:	298,4

Tävling

7  
8 8 7  
8 7  
7

31: 9,2	↗
32: 10,2*	↗
33: 10,6*	←
34: 9,4	↗
35: 10,3*	↗
<hr/>	
Serie:	49,7
Summa:	348,1

Tävling

7  
8 7  
8 7  
7

36: 10,3*	←
37: 9,9	↗
38: 9,6	↗
39: 9,2	↑
40: 9,6	↖
<hr/>	
Serie:	48,6
Summa:	396,7

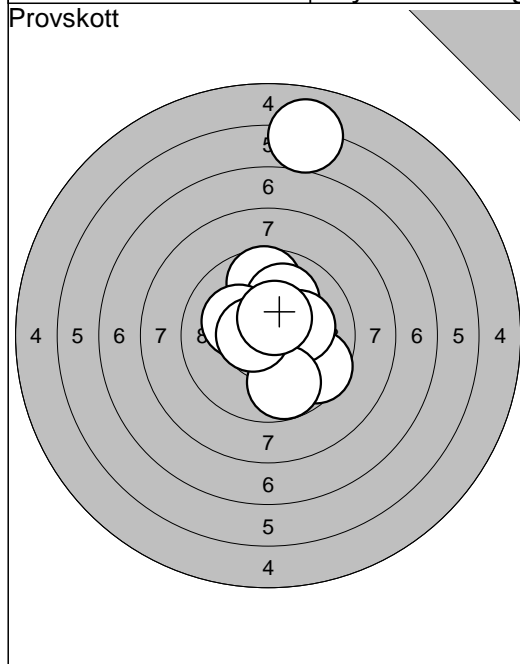

1: 6,1	↑
2: 9,6	↘
3: 9,7	↑
4: 10,0	↗
5: 10,6*	→
6: 10,2*	↗
7: 9,8	↓
8: 10,2*	↖
9: 10,6*	←
10: 10,5*	↗
Serie: 97,3	
Summa: 0,0	

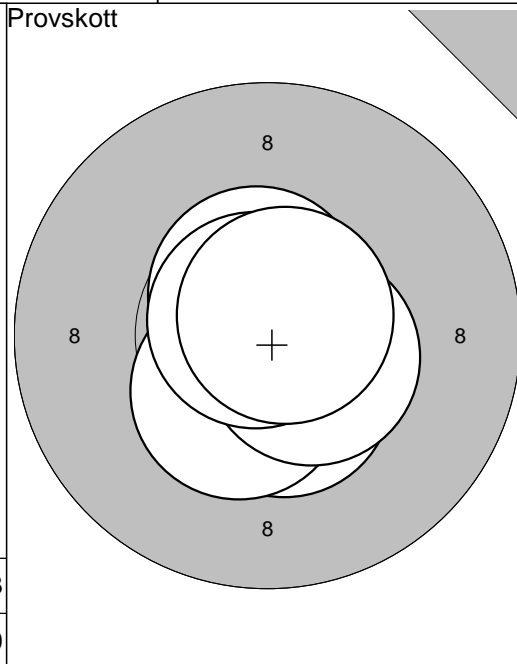

11: 10,6*	↑
12: 10,5*	↓
13: 10,4*	↘
14: 10,5*	↘
15: 10,8*	↖
16: 10,7*	↗
Serie: 63,5	
Summa: 0,0	

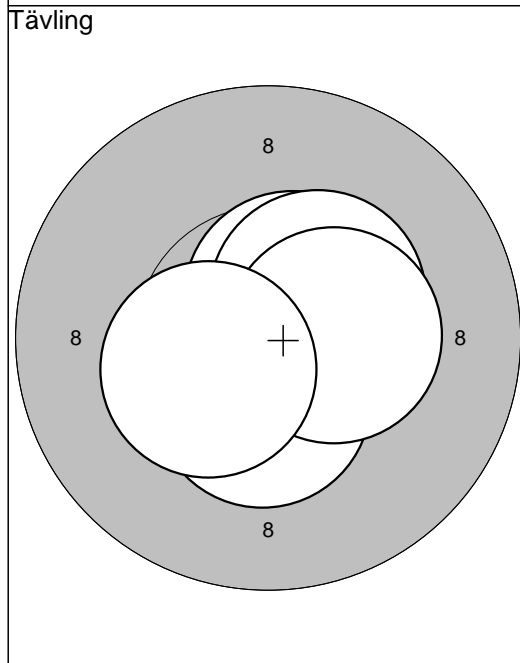

1: 10,6*	↗
2: 10,4*	↗
3: 10,4*	↓
4: 10,4*	→
5: 10,4*	↖
Serie: 52,2	
Summa: 52,2	

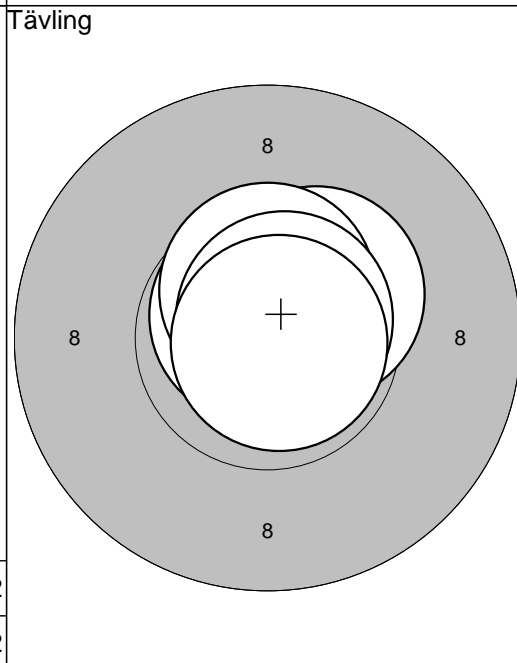

6: 10,8*	↖
7: 10,4*	↗
8: 10,6*	↑
9: 10,7*	↗
10: 10,8*	↘
Serie: 53,3	
Summa: 105,5	

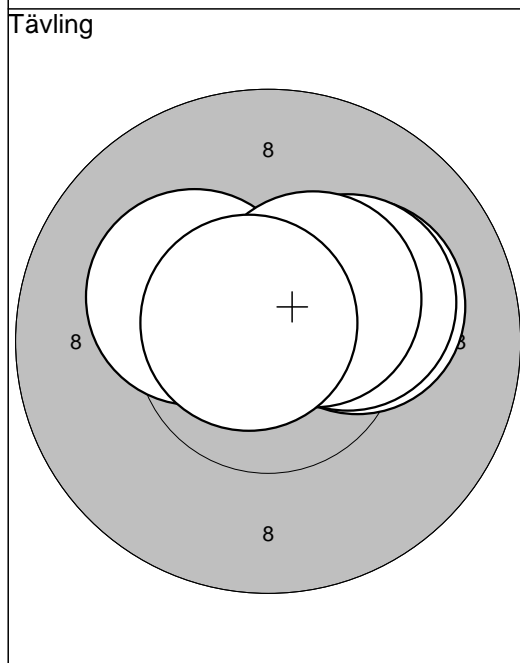

11: 10,2*	↖
12: 10,2*	↗
13: 10,2*	↗
14: 10,4*	↗
15: 10,7*	↖
Serie: 51,7	
Summa: 157,2	

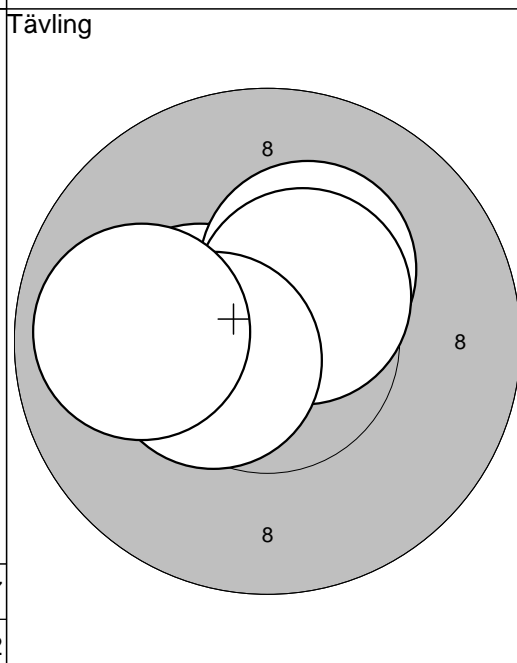

16: 10,4*	←
17: 10,3*	↗
18: 10,5*	↗
19: 10,5*	←
20: 9,9	←
Serie: 51,6	
Summa: 208,8	

Tävling

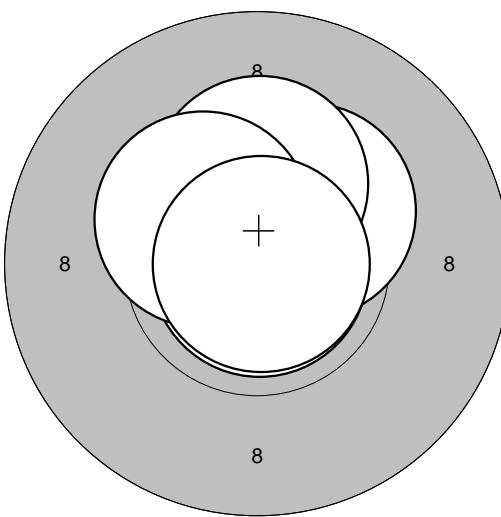

Target diagram showing five shots clustered in the center. The number 8 is marked at the top, bottom, left, and right of the target.

21: 10,9*	↘
22: 10,3*	↗
23: 10,3*	↑
24: 10,4*	↖
25: 10,9*	→
Serie: 52,8	
Summa: 261,6	

Tävling

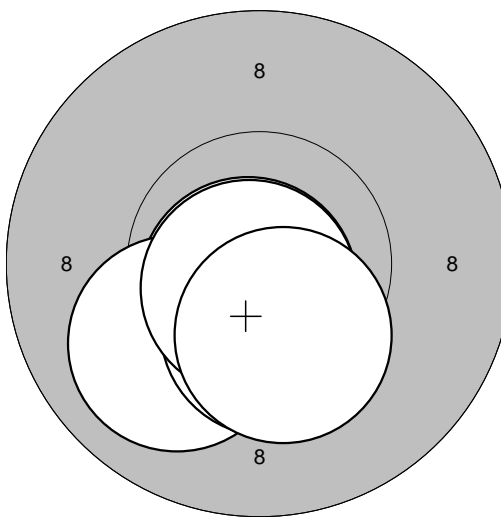

Target diagram showing five shots clustered in the center. The number 8 is marked at the top, bottom, left, and right of the target.

26: 10,7*	↘
27: 10,0	↙
28: 10,4*	↘
29: 10,7*	↘
30: 10,3*	↘
Serie: 52,1	
Summa: 313,7	

Tävling

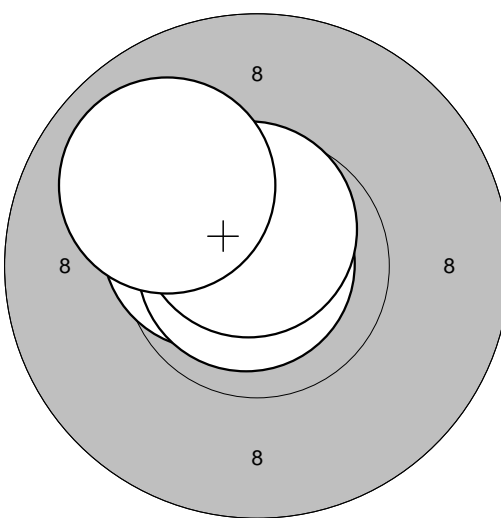

Target diagram showing five shots clustered in the center. The number 8 is marked at the top, bottom, left, and right of the target.

31: 10,8*	↖
32: 10,5*	↖
33: 10,9*	←
34: 10,6*	↑
35: 10,0	↗
Serie: 52,8	
Summa: 366,5	

Tävling

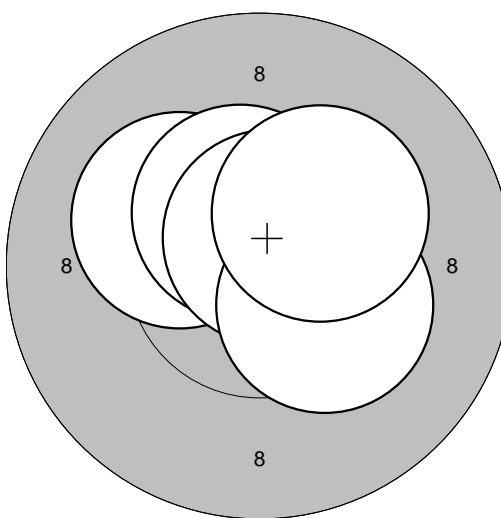

Target diagram showing five shots clustered in the center. The number 8 is marked at the top, bottom, left, and right of the target.

36: 10,2*	↖
37: 10,5*	↑
38: 10,7*	↗
39: 10,3*	↘
40: 10,3*	↗
Serie: 52,0	
Summa: 418,5	

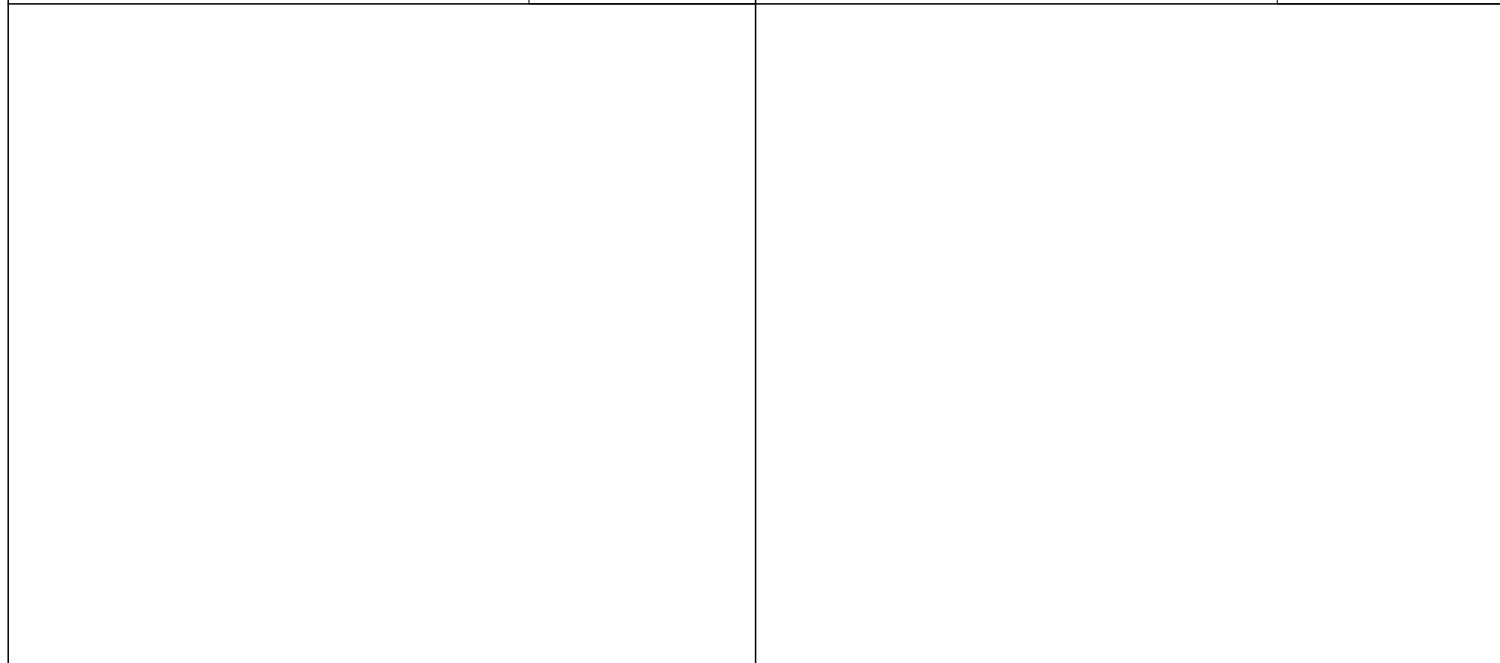

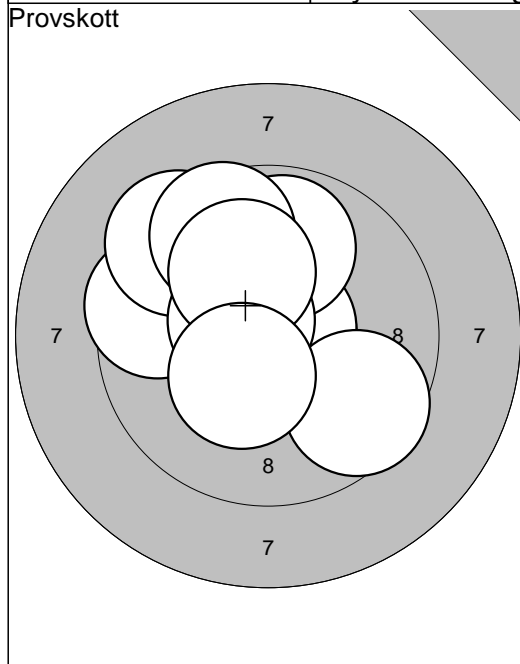

1: 10,6*	↖
2: 10,7*	↗
3: 9,6	↙
4: 9,4	↗
5: 9,9	↑
6: 9,6	↗
7: 10,6*	↖
8: 9,6	↘
9: 10,1	↗
10: 10,4*	↘
Serie: 100,5	
Summa: 0,0	

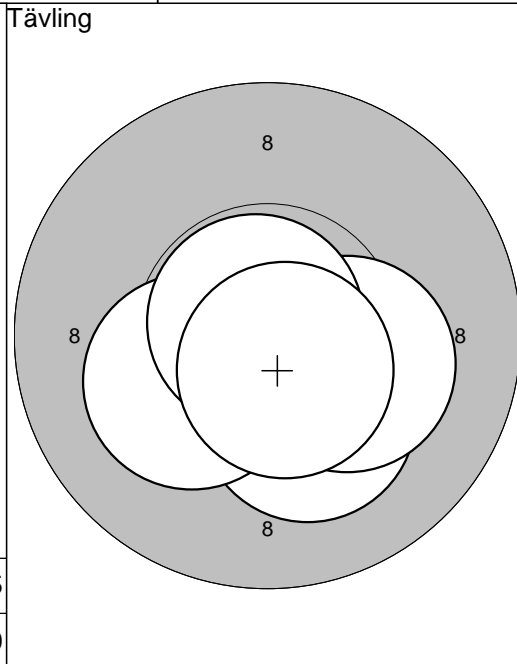

1: 10,2*	↘
2: 10,2*	↙
3: 10,2*	↗
4: 10,8*	↗
5: 10,6*	↘
Serie: 52,0	
Summa: 52,0	

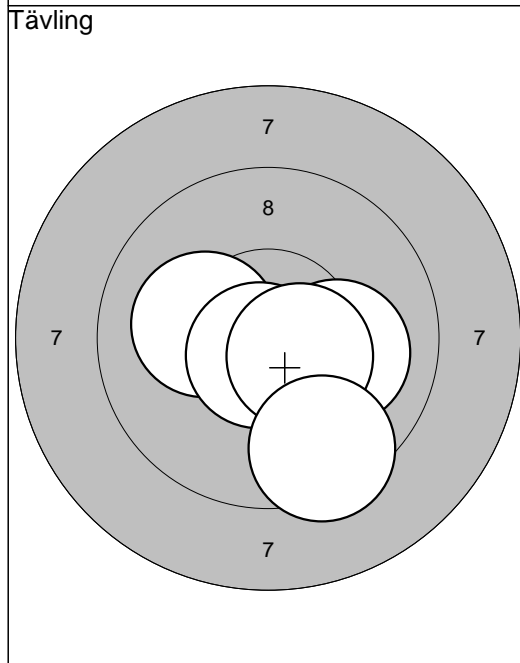

6: 10,1	→
7: 10,2*	↙
8: 10,7*	↘
9: 10,5*	↘
10: 9,4	↘
Serie: 50,9	
Summa: 102,9	

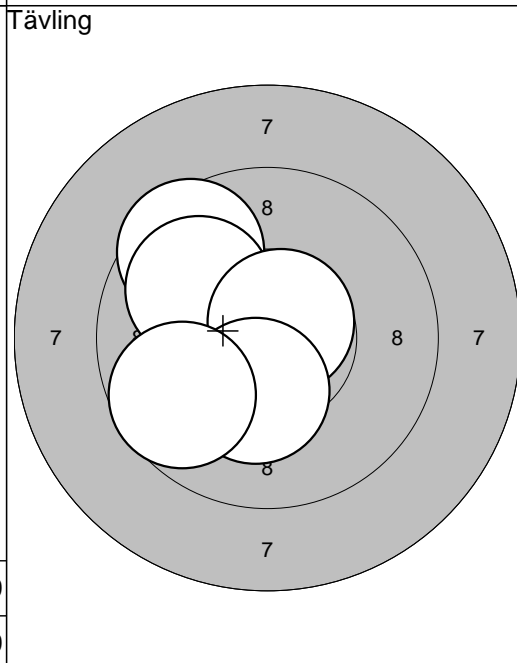

11: 9,5	↖
12: 9,9	↖
13: 10,7*	↗
14: 10,3*	↘
15: 9,7	↙
Serie: 50,1	
Summa: 153,0	

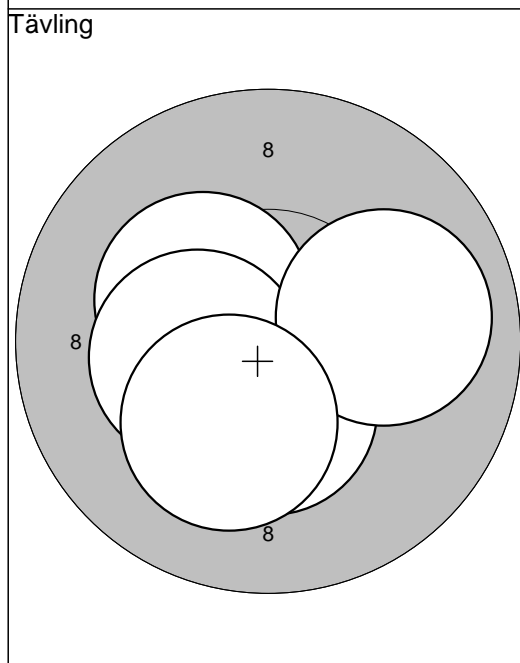

16: 10,3*	↖
17: 10,4*	↓
18: 10,3*	↙
19: 10,0	→
20: 10,2*	↘
Serie: 51,2	
Summa: 204,2	

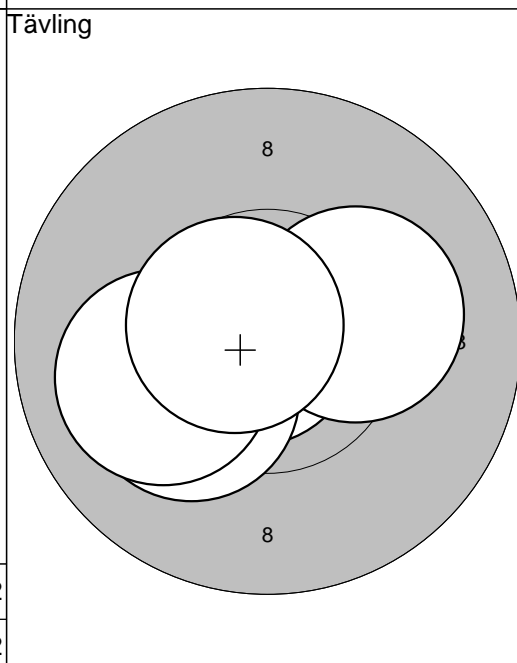

21: 10,8*	↙
22: 10,2*	↙
23: 10,0	↙
24: 10,2*	→
25: 10,7*	↖
Serie: 51,9	
Summa: 256,1	



Tävling

26: 10,2*	↘
27: 10,3*	↓
28: 10,7*	↗
29: 10,8*	↓
30: 9,8	↓
<hr/>	
Serie:	51,8
Summa:	307,9

Tävling

31: 10,5*	↘
32: 10,0	↗
33: 10,2*	↘
34: 10,9*	↘
35: 10,2*	↗
<hr/>	
Serie:	51,8
Summa:	359,7

Tävling

36: 10,4*	↓
37: 9,6	↙
38: 10,4*	↓
39: 9,6	↘
40: 10,0	↓
<hr/>	
Serie:	50,0
Summa:	409,7

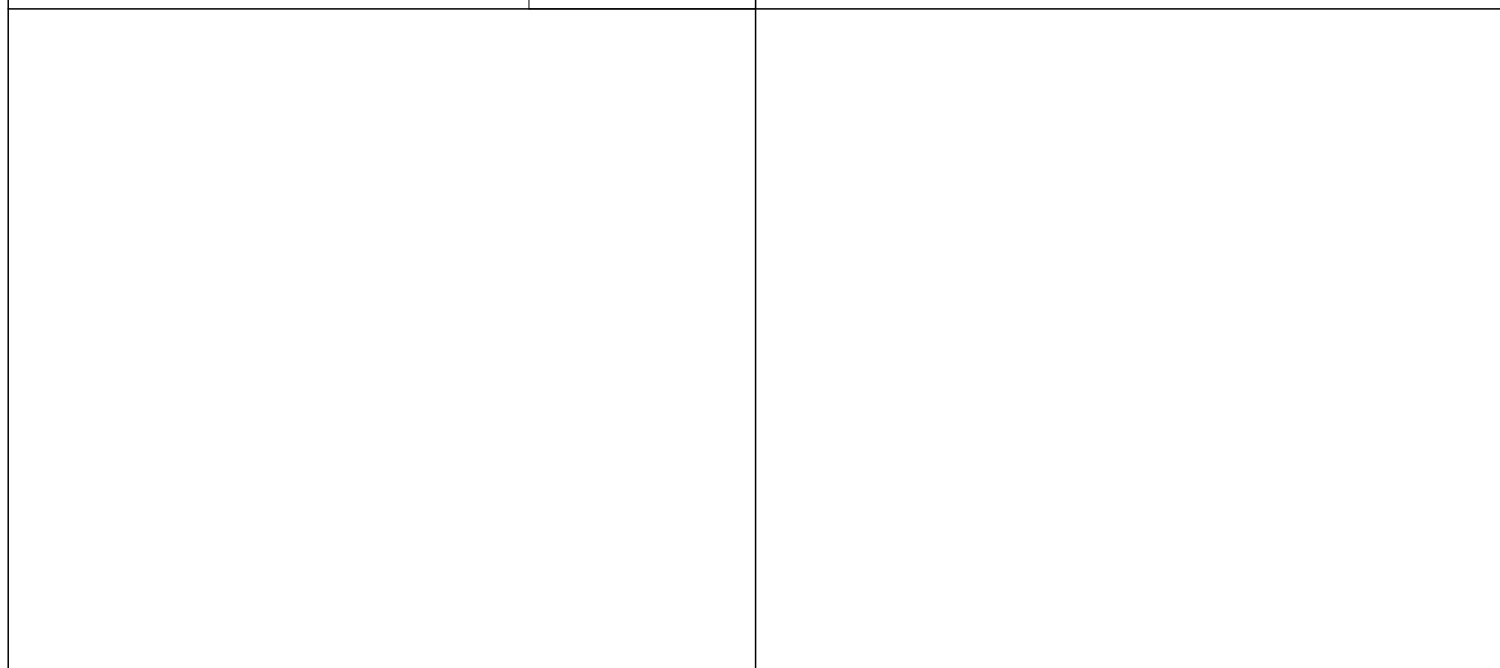

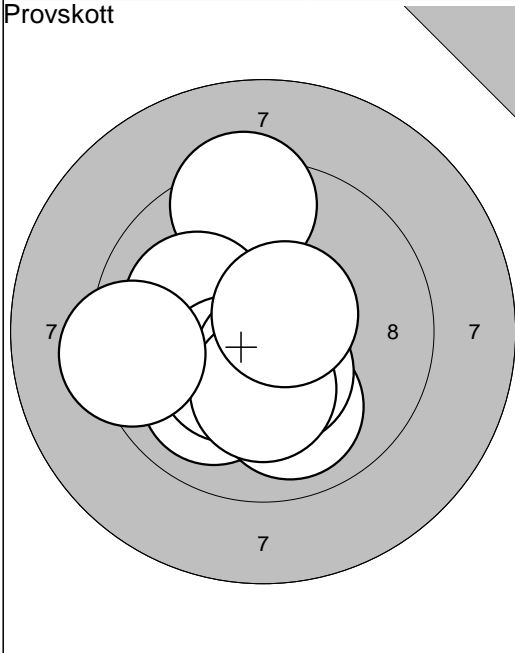

1: 10,0	↙
2: 9,4	↑
3: 10,0	↘
4: 10,1	↖
5: 10,3*	↘
6: 10,6*	↘
7: 10,4*	↘
8: 10,2*	↘
9: 10,6*	↗
10: 9,3	←
<b>Serie: 100,9</b>	
<b>Summa: 0,0</b>	

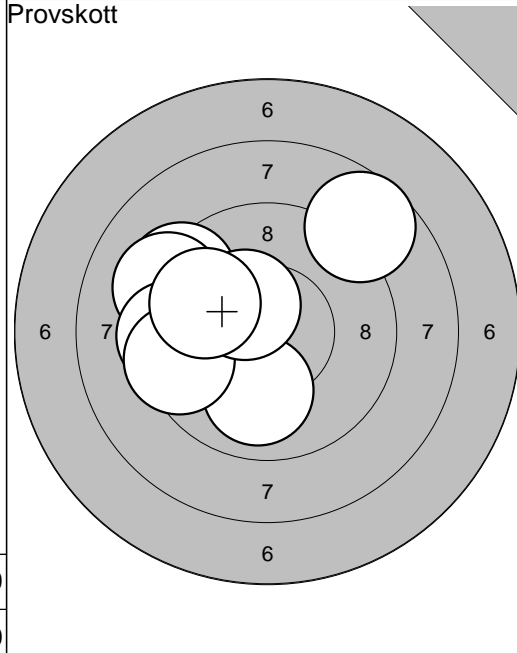

11: 10,0	↓
12: 9,3	↖
13: 9,2	↖
14: 9,4	←
15: 9,5	←
16: 8,7	↗
17: 10,4*	↗
18: 9,9	↖
<b>Serie: 76,4</b>	
<b>Summa: 0,0</b>	

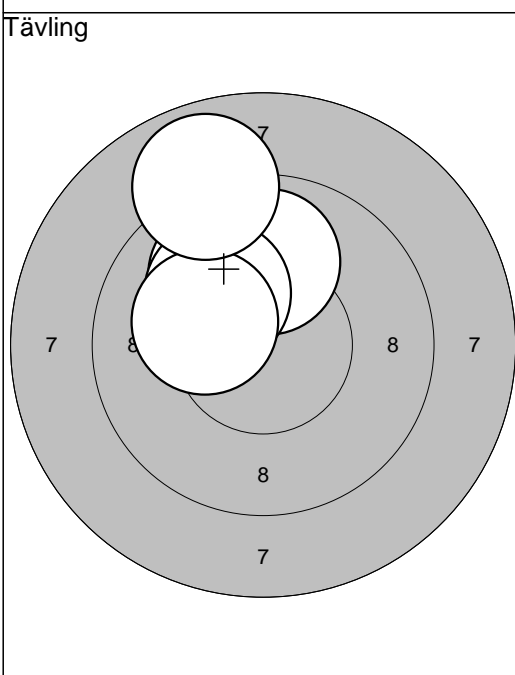

1: 10,0	↖
2: 9,9	↑
3: 10,1	↗
4: 10,2*	↖
5: 8,9	↑
<b>Serie: 49,1</b>	
<b>Summa: 49,1</b>	

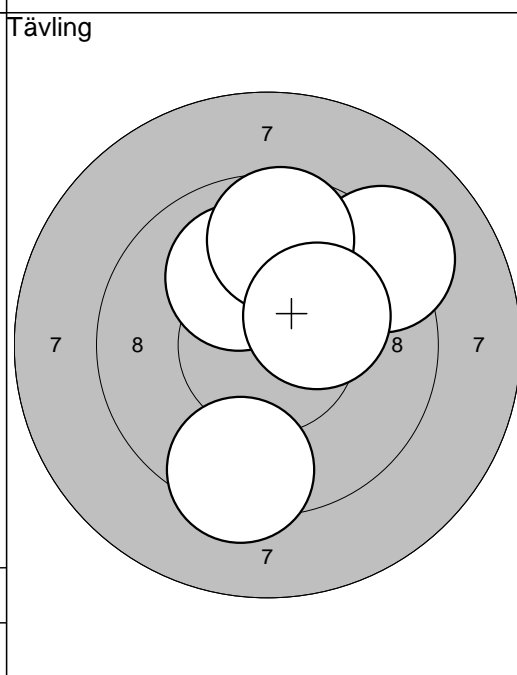

6: 9,4	↓
7: 10,1	↖
8: 9,2	↗
9: 9,7	↑
10: 10,2*	↗
<b>Serie: 48,6</b>	
<b>Summa: 97,7</b>	

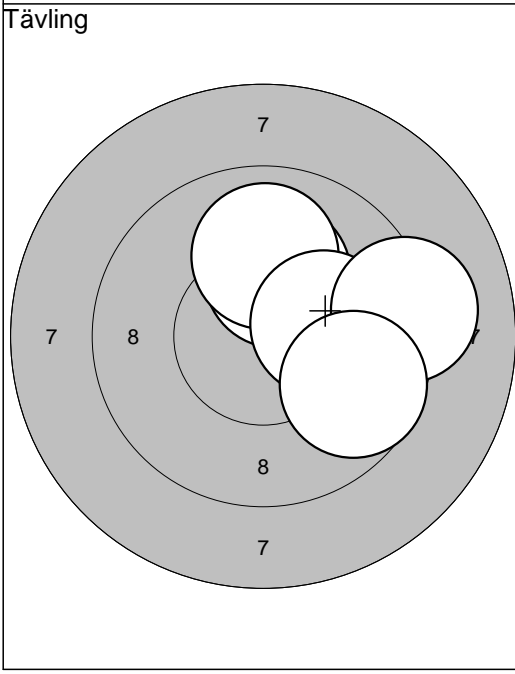

11: 10,2*	↑
12: 10,0	↑
13: 10,2*	→
14: 9,2	→
15: 9,7	↘
<b>Serie: 49,3</b>	
<b>Summa: 147,0</b>	

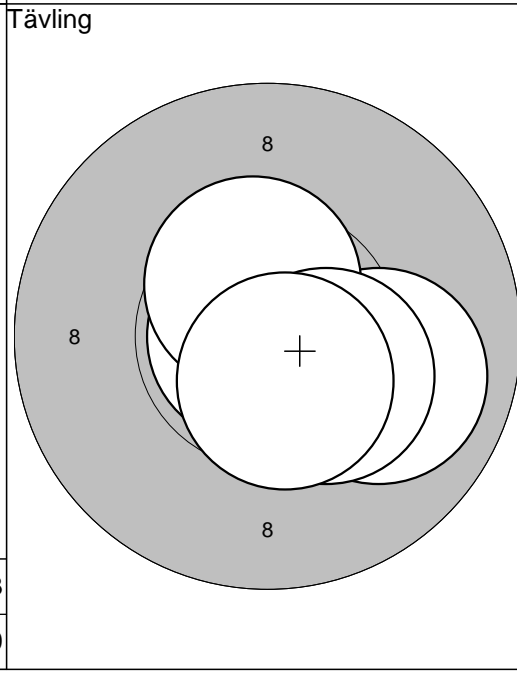

16: 10,0	↘
17: 10,9*	←
18: 10,5*	↑
19: 10,4*	↘
20: 10,5*	↘
<b>Serie: 52,3</b>	
<b>Summa: 199,3</b>	

Tävling

21: 9,9	↓
22: 9,7	↓
23: 10,0	↓
24: 10,1	↓
25: 10,1	↓
<b>Serie: 49,8</b>	
<b>Summa: 249,1</b>	

Tävling

26: 10,4*	↗
27: 9,8	↗
28: 10,7*	↖
29: 9,5	↗
30: 10,8*	↙
<b>Serie: 51,2</b>	
<b>Summa: 300,3</b>	

Tävling

31: 10,7*	↗
32: 10,3*	→
33: 9,9	→
34: 10,3*	↖
35: 10,2*	↗
<b>Serie: 51,4</b>	
<b>Summa: 351,7</b>	

Tävling

36: 10,1	↗
37: 10,6*	↓
38: 9,5	↗
39: 10,4*	→
40: 10,0	↖
<b>Serie: 50,6</b>	
<b>Summa: 402,3</b>	

--	--

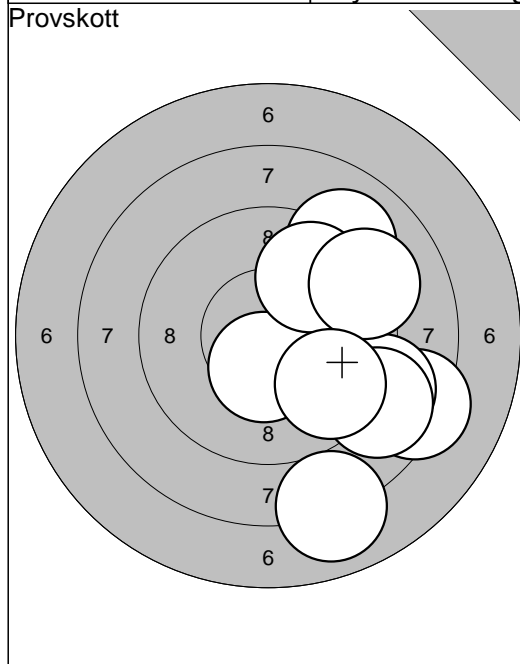

1: 9,1 ↗
2: 10,2* ↘
3: 8,3 ↘
4: 10,4* ↓
5: 8,9 ↘
6: 9,8 ↗
7: 9,2 →
8: 8,9 ↘
9: 9,7 ↘
10: 8,0 ↓
Serie: 92,5
Summa: 0,0

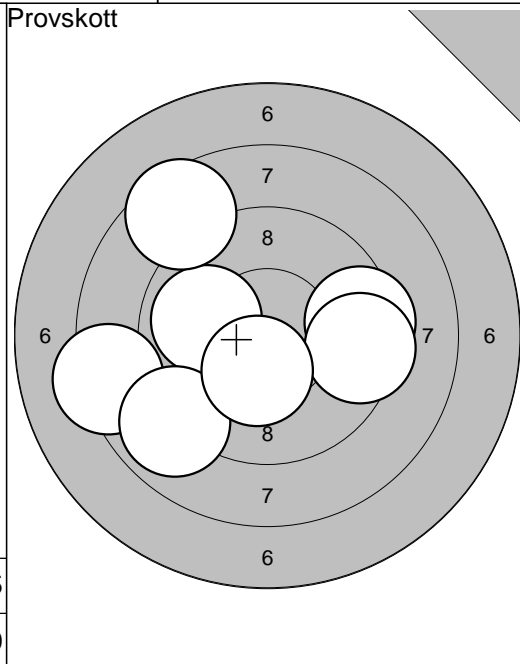

11: 9,4 →
12: 9,9 ←
13: 8,3 ←
14: 8,9 ↘
15: 9,4 →
16: 8,5 ↗
17: 10,3* ↓
Serie: 64,7
Summa: 0,0

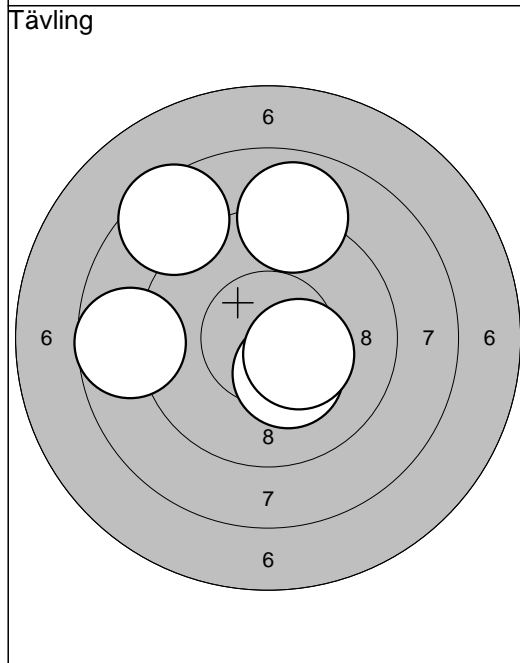

1: 10,3* ↓
2: 8,5 ↗
3: 9,0 ↑
4: 10,4* ↘
5: 8,7 ←
Serie: 46,9
Summa: 46,9

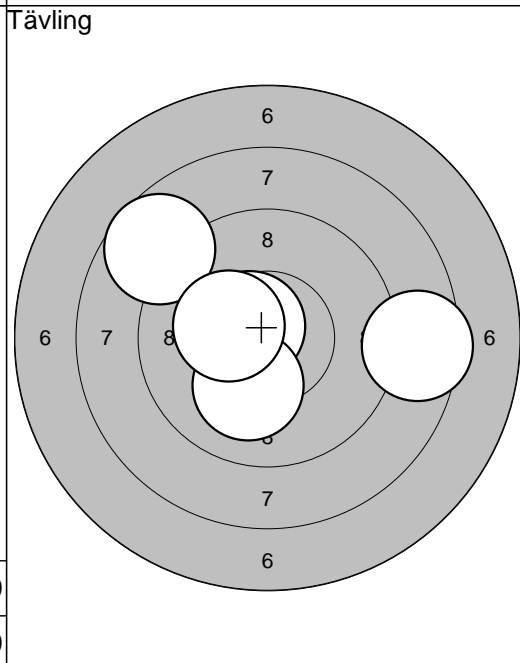

6: 10,6* ↗
7: 10,1 ↓
8: 8,7 ↗
9: 8,5 →
10: 10,3* ←
Serie: 48,2
Summa: 95,1

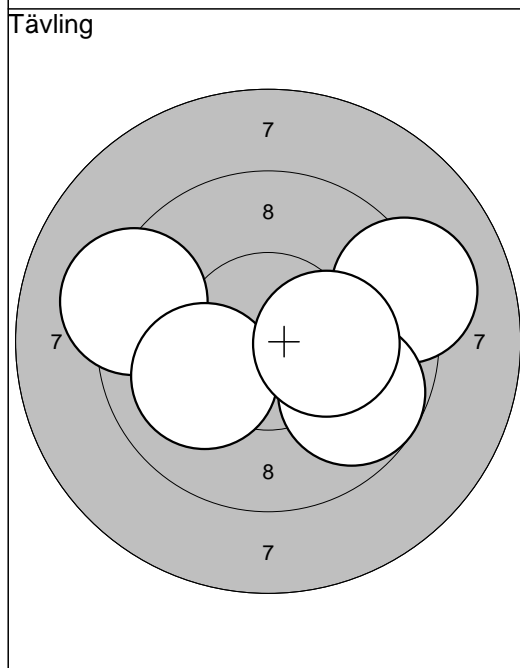

11: 9,2 →
12: 9,2 ←
13: 10,1 ←
14: 9,7 ↘
15: 10,2* →
Serie: 48,4
Summa: 143,5

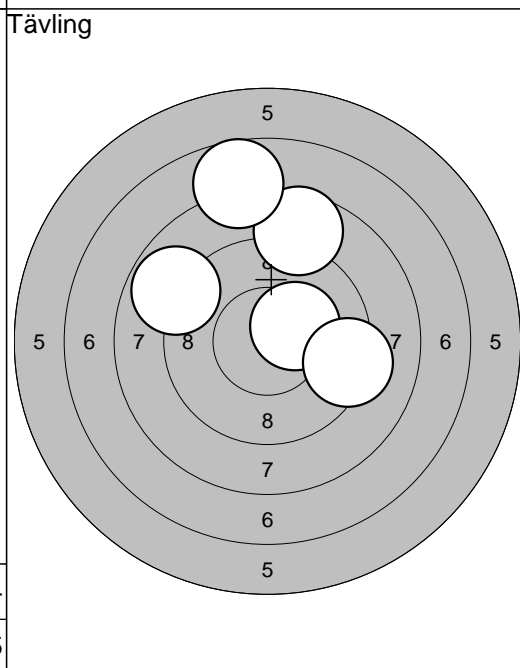

16: 10,3* ↗
17: 8,9 ←
18: 8,6 ↑
19: 7,7 ↑
20: 9,3 →
Serie: 44,8
Summa: 188,3

Tävling

21: 10,3*	↓
22: 9,5	↑
23: 9,6	↙
24: 10,9*	↓
25: 8,1	←
<b>Serie: 48,4</b>	
<b>Summa: 236,7</b>	

Tävling

26: 9,1	↑
27: 8,3	↖
28: 10,2*	→
29: 10,0	↑
30: 9,5	→
<b>Serie: 47,1</b>	
<b>Summa: 283,8</b>	

Tävling

31: 9,5	↑
32: 8,8	↑
33: 8,9	↑
34: 10,1	→
35: 8,5	↗
<b>Serie: 45,8</b>	
<b>Summa: 329,6</b>	

Tävling

36: 10,3*	←
37: 10,6*	↑
38: 8,5	↖
39: 9,4	↓
40: 7,5	↖
<b>Serie: 46,3</b>	
<b>Summa: 375,9</b>	

--	--