

1: 10,0	↙
2: 10,2*	↘
3: 10,3*	↓
4: 10,0	←
5: 10,2*	↘
6: 9,6	↘
7: 10,1	←
8: 10,7*	↘
9: 10,6*	←
10: 10,8*	↑
<b>Serie: 99,0</b>	
<b>Summa: 0,0</b>	

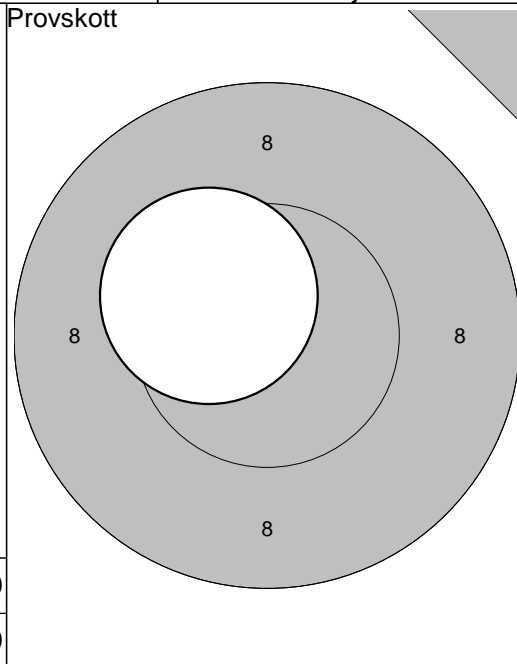

11: 10,4*	↖
<b>Serie: 10,0</b>	
<b>Summa: 0,0</b>	

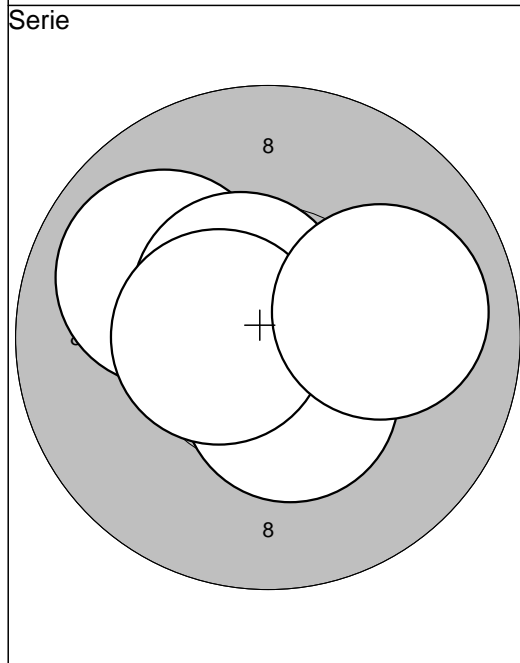

1: 10,4*	↘
2: 10,0	↖
3: 10,6*	↗
4: 10,5*	←
5: 10,0	→
<b>Serie: 50,0</b>	
<b>Summa: 50,0</b>	

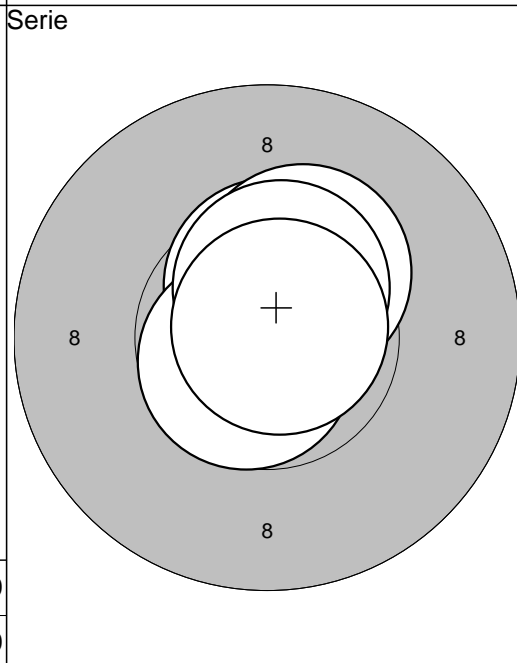

6: 10,5*	↑
7: 10,7*	↙
8: 10,3*	↗
9: 10,5*	↑
10: 10,8*	↗
<b>Serie: 50,0</b>	
<b>Summa: 100,0</b>	

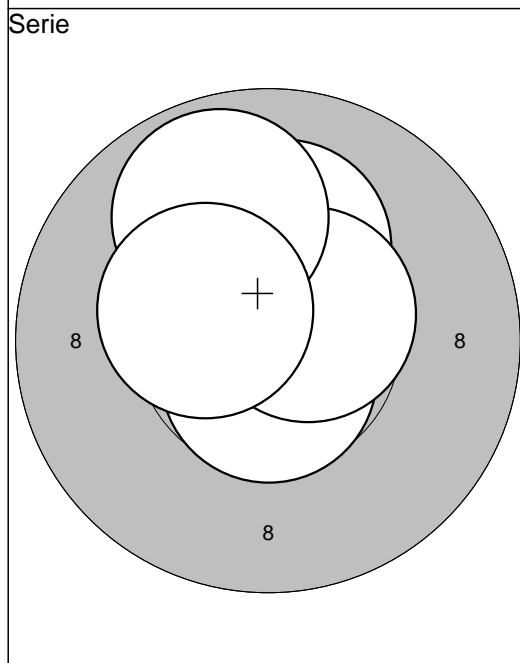

11: 10,7*	↓
12: 10,2*	↑
13: 10,6*	↗
14: 9,9	↗
15: 10,4*	↖
<b>Serie: 49,0</b>	
<b>Summa: 149,0</b>	

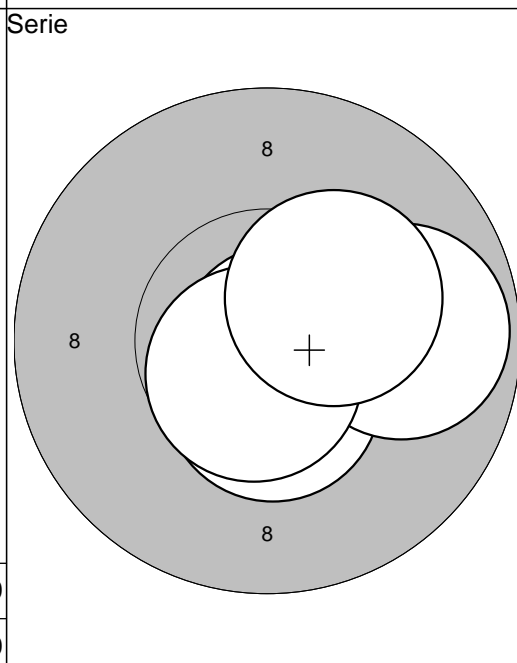

16: 10,8*	↘
17: 10,5*	↓
18: 9,8	→
19: 10,7*	↘
20: 10,3*	↗
<b>Serie: 49,0</b>	
<b>Summa: 198,0</b>	

Serie

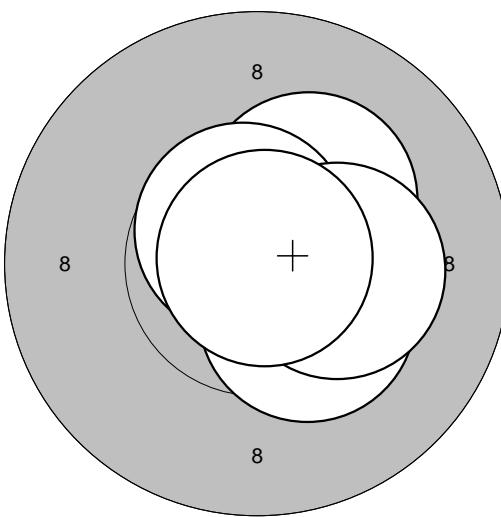

21: 10,3\* ↗  
22: 10,4\* ↘  
23: 10,7\* ↗  
24: 10,3\* →  
25: 10,9\* ↗

Serie:	50,0
Summa:	248,0

Serie

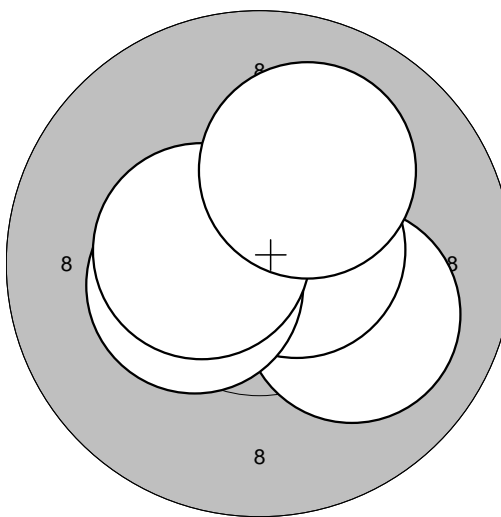

26: 10,1 ↘  
27: 10,6\* →  
28: 10,4\* ←  
29: 10,5\* ←  
30: 10,1 ↗

Serie:	50,0
Summa:	298,0

Serie

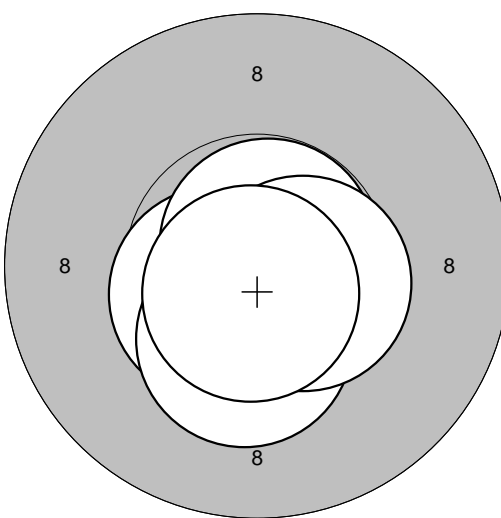

31: 10,5\* ↙  
32: 10,8\* ↗  
33: 10,3\* ↓  
34: 10,5\* →  
35: 10,7\* ↓

Serie:	50,0
Summa:	348,0

Serie

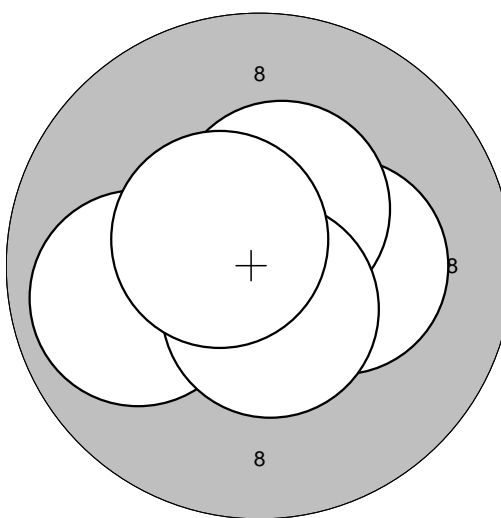

36: 10,3\* →  
37: 9,9 ←  
38: 10,4\* ↗  
39: 10,6\* ↓  
40: 10,6\* ↙

Serie:	49,0
Summa:	397,0

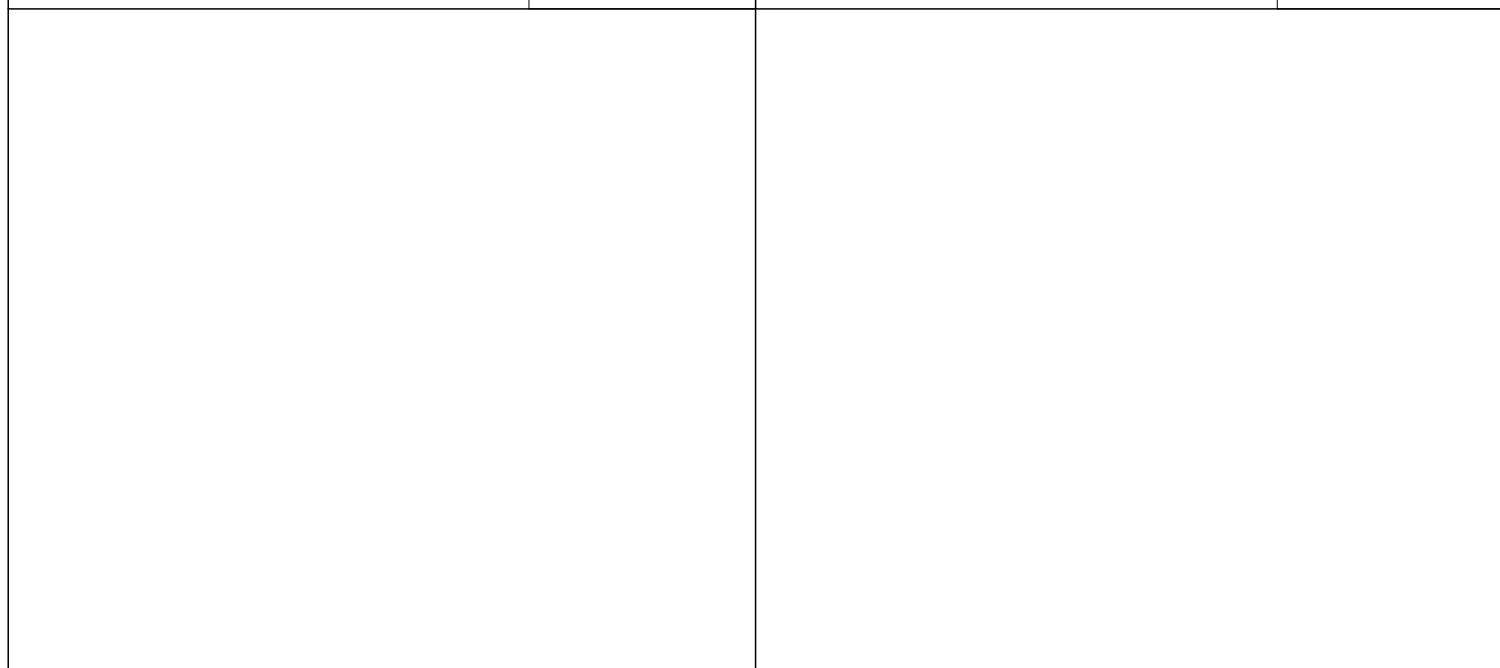

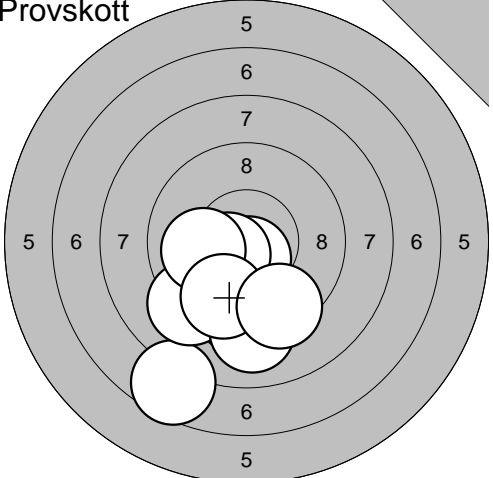
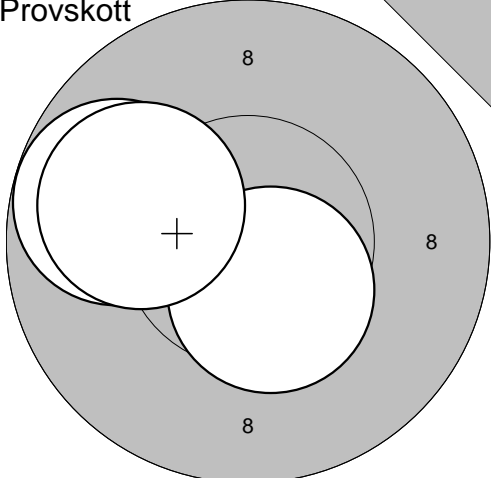
<p><b>Provskott</b></p>  <p>5 6 7 8 8 7 6 5 5 6 7 8 7 6 5 6 5</p>	<p>1: 10,2* ↓ 2: 10,6* ↓ 3: 9,5 ↓ 4: 7,6 ↓ 5: 9,2 ↙ 6: 9,1 ↓ 7: 10,5* ↙ 8: 10,0 ← 9: 9,7 ↓ 10: 9,4 ↓</p> <p>Serie: 92,0 Summa: 0,0</p>	<p><b>Provskott</b></p>  <p>8 8</p> <p>11: 9,8 ← 12: 10,5* ↓ 13: 10,0 ↙</p> <p>Serie: 29,0 Summa: 0,0</p>
---	--	---

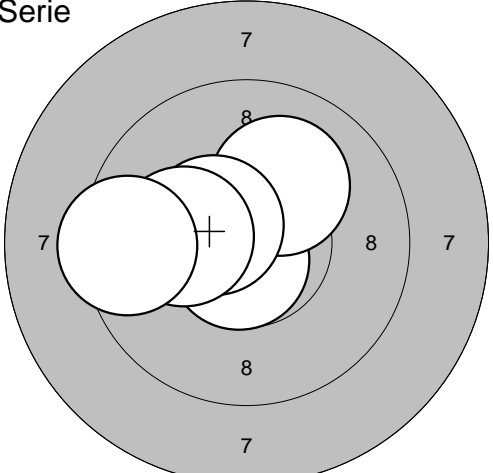
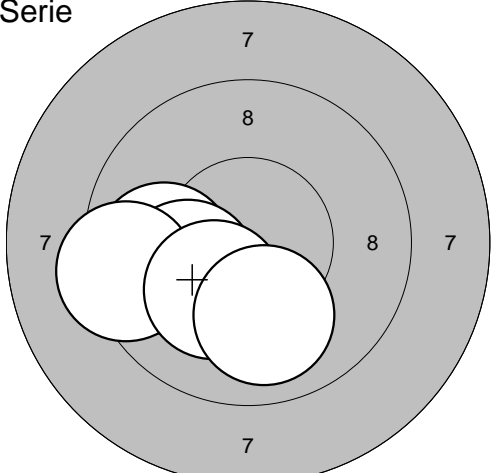
<p><b>Serie</b></p>  <p>7 8 7 8 7</p>	<p>1: 10,7* ↓ 2: 10,1 ↗ 3: 10,5* ↙ 4: 10,1 ← 5: 9,4 ←</p> <p>Serie: 49,0 Summa: 49,0</p>	<p><b>Serie</b></p>  <p>7 8 7 7</p> <p>6: 9,9 ← 7: 10,1 ← 8: 9,3 ← 9: 10,2* ↓ 10: 10,0 ↓</p> <p>Serie: 48,0 Summa: 97,0</p>
--	--	--

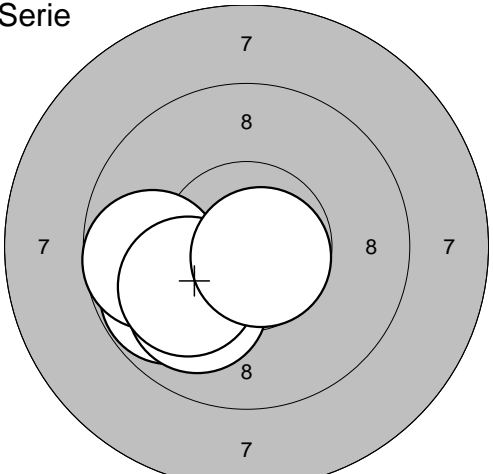
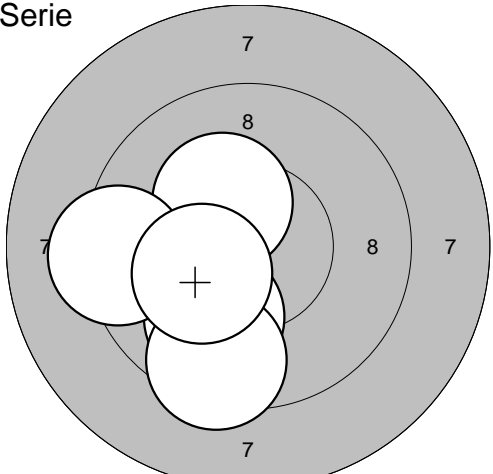
<p><b>Serie</b></p>  <p>7 8 7 8 7</p>	<p>11: 9,8 ← 12: 10,0 ↓ 13: 9,7 ← 14: 10,0 ← 15: 10,7* ↓</p> <p>Serie: 48,0 Summa: 145,0</p>	<p><b>Serie</b></p>  <p>7 8 7</p> <p>16: 9,9 ↓ 17: 10,3* ↗ 18: 9,3 ← 19: 9,4 ↓ 20: 10,3* ↙</p> <p>Serie: 47,0 Summa: 192,0</p>
---	--	--

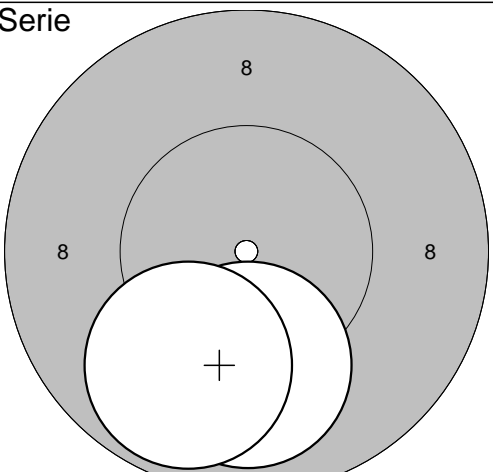
<p><b>Serie</b></p>  <p>8 8</p>	<p>21: 10,0 ↓ 22: 9,8 ↓</p> <p>Serie: 19,0 Summa: 211,0</p>	
---	---	--

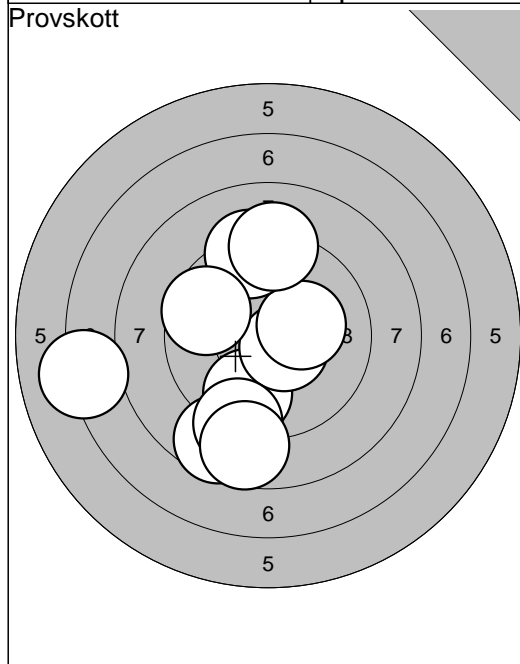

1: 8,6	↘
2: 9,7	↘
3: 10,5*	↘
4: 10,2*	→
5: 9,3	↑
6: 7,2	←
7: 9,6	↙
8: 9,1	↘
9: 8,7	↘
10: 9,2	↑
<b>Serie: 88,0</b>	
<b>Summa: 0,0</b>	

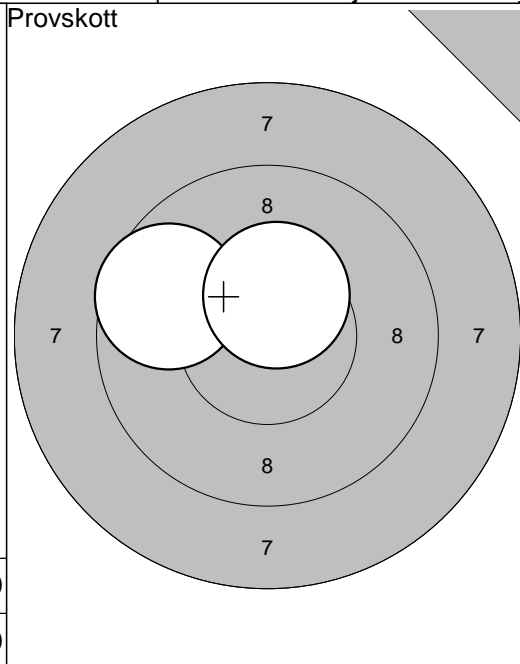

11: 9,7	↙
12: 10,4*	↑
<b>Serie: 19,0</b>	
<b>Summa: 0,0</b>	

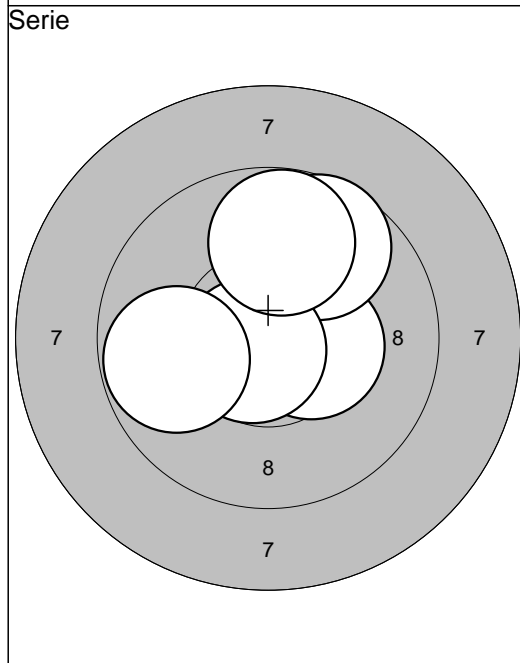

1: 10,4*	→
2: 9,7	↗
3: 10,7*	↙
4: 9,8	↑
5: 9,8	←
<b>Serie: 47,0</b>	
<b>Summa: 47,0</b>	

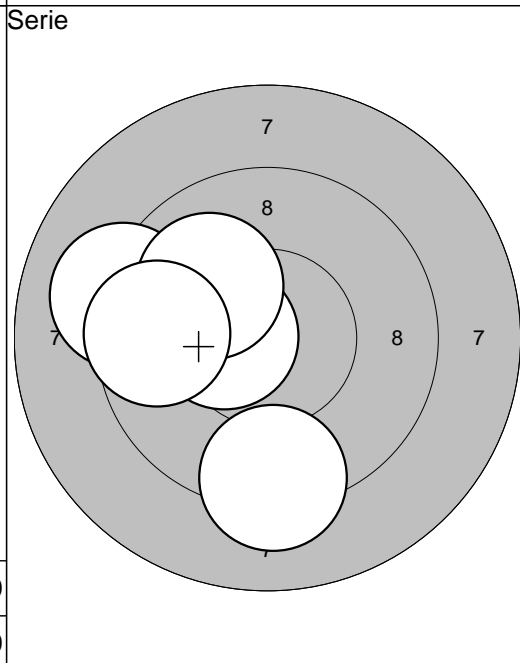

6: 9,1	↙
7: 9,2	↘
8: 10,4*	←
9: 10,0	↗
10: 9,6	←
<b>Serie: 47,0</b>	
<b>Summa: 94,0</b>	

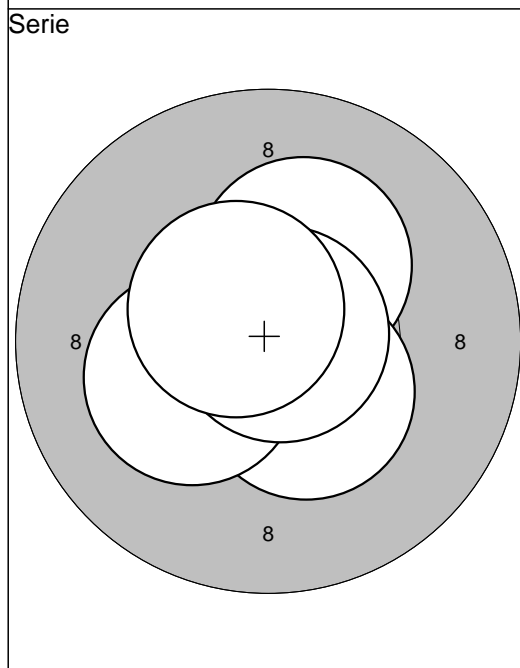

11: 10,3*	↗
12: 10,4*	↘
13: 10,3*	↙
14: 10,8*	→
15: 10,6*	↙
<b>Serie: 50,0</b>	
<b>Summa: 144,0</b>	

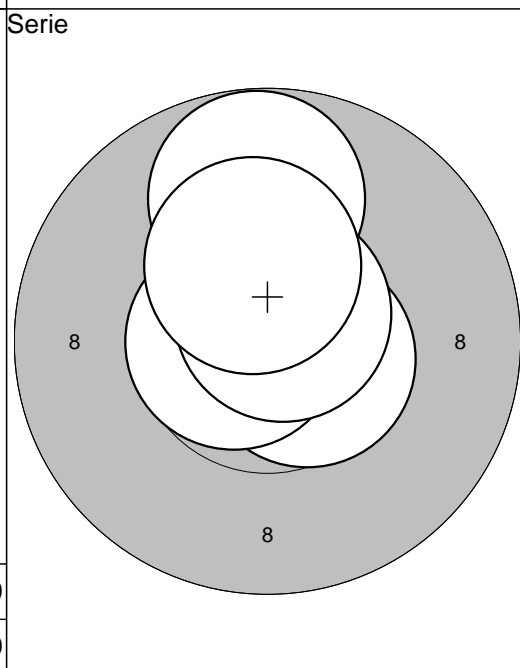

16: 10,6*	↘
17: 9,8	↑
18: 10,7*	←
19: 10,7*	↗
20: 10,3*	↑
<b>Serie: 49,0</b>	
<b>Summa: 193,0</b>	

Serie

Serie: 49,0	
Summa: 242,0	

21: 10,6\* ↘  
 22: 10,3\* ↘  
 23: 9,7 ↘  
 24: 10,2\* ←  
 25: 10,5\* ↓

Serie

Serie: 48,0	
Summa: 290,0	

26: 10,2\* ←  
 27: 10,2\* ←  
 28: 9,8 ↙  
 29: 9,5 ←  
 30: 10,1 ↖

Serie

Serie: 49,0	
Summa: 339,0	

31: 9,9 ↙  
 32: 10,0 ←  
 33: 10,2\* ↖  
 34: 10,6\* ↗  
 35: 10,0 ↗

Serie

Serie: 46,0	
Summa: 385,0	

36: 9,7 ↗  
 37: 10,9\* ↗  
 38: 10,6\* ↗  
 39: 8,7 ↖  
 40: 9,7 ↗

--	--

Provskott

1: 7,8	←
2: 7,9	←
3: 9,0	↗
4: 9,7	↗
5: 9,3	↗
6: 10,2*	↘
7: 9,5	↗
8: 9,5	→
9: 9,0	↗
10: 10,3*	↘
<b>Serie: 88,0</b>	
<b>Summa: 0,0</b>	

Provskott

11: 9,8	↗
12: 10,0	↘
13: 9,8	↘
14: 8,9	↗
15: 10,1	↗
16: 10,7*	←
<b>Serie: 56,0</b>	
<b>Summa: 0,0</b>	

Serie

1: 9,6	↘
2: 10,2*	→
3: 10,2*	↗
4: 9,9	↘
5: 9,9	↗
<b>Serie: 47,0</b>	
<b>Summa: 47,0</b>	

Serie

6: 10,0	←
7: 9,3	↗
8: 10,0	↗
9: 10,5*	↘
10: 9,6	↗
<b>Serie: 48,0</b>	
<b>Summa: 95,0</b>	

Serie

11: 9,5	↗
12: 9,3	↗
13: 9,3	↘
14: 9,5	↗
15: 9,6	←
<b>Serie: 45,0</b>	
<b>Summa: 140,0</b>	

Serie

16: 10,1	→
17: 9,7	↘
18: 10,6*	↘
19: 9,6	↘
20: 10,3*	←
<b>Serie: 48,0</b>	
<b>Summa: 188,0</b>	

Serie

Serie:	49,0
Summa:	237,0

- 21: 10,8\* ←
- 22: 10,3\* →
- 23: 10,7\* ↘
- 24: 10,4\* ↗
- 25: 9,9 ↑

Serie

Serie:	47,0
Summa:	284,0

- 26: 9,8 ←
- 27: 9,9 →
- 28: 10,7\* ↑
- 29: 9,7 ↘
- 30: 10,4\* ↗

Serie

Serie:	46,0
Summa:	330,0

- 31: 10,0 ↑
- 32: 10,3\* →
- 33: 8,8 ↗
- 34: 9,7 ↓
- 35: 9,6 ↘

Serie

Serie:	47,0
Summa:	377,0

- 36: 10,3\* ↖
- 37: 9,2 ↑
- 38: 10,4\* ←
- 39: 9,1 ↗
- 40: 9,8 ↑

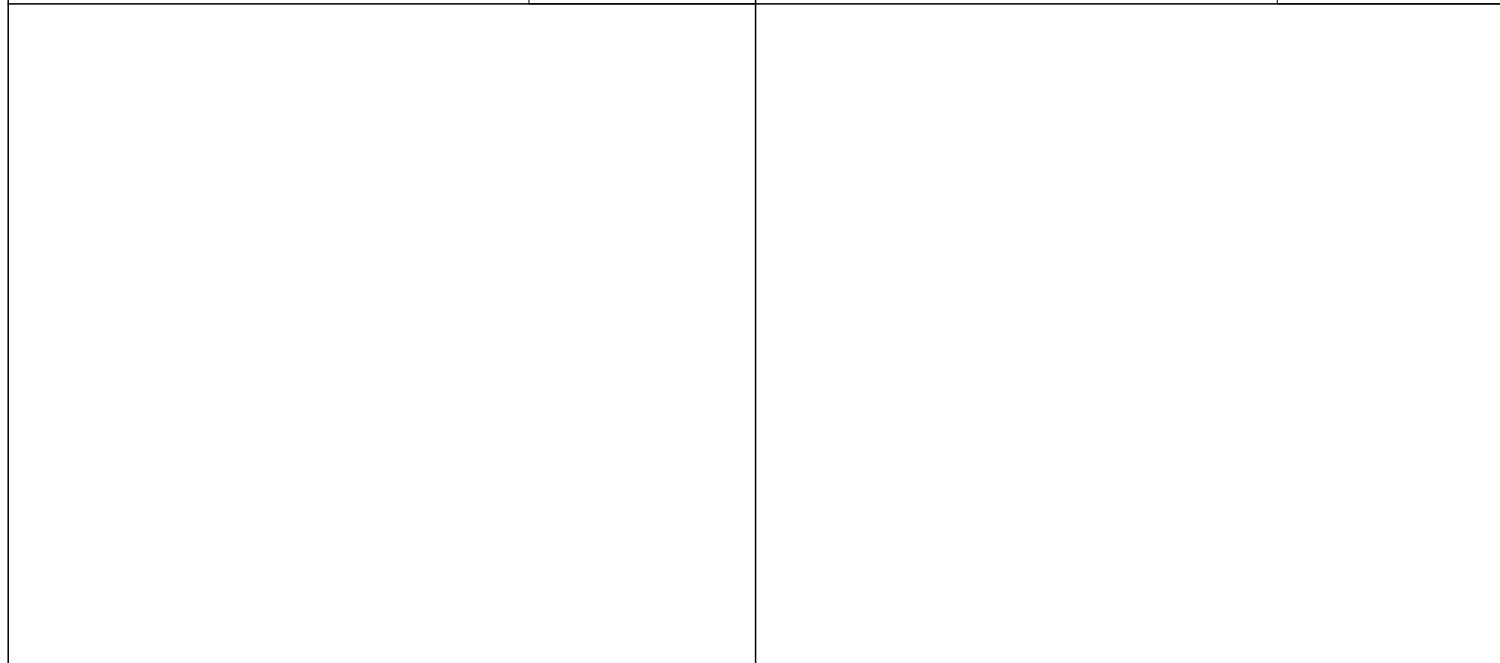

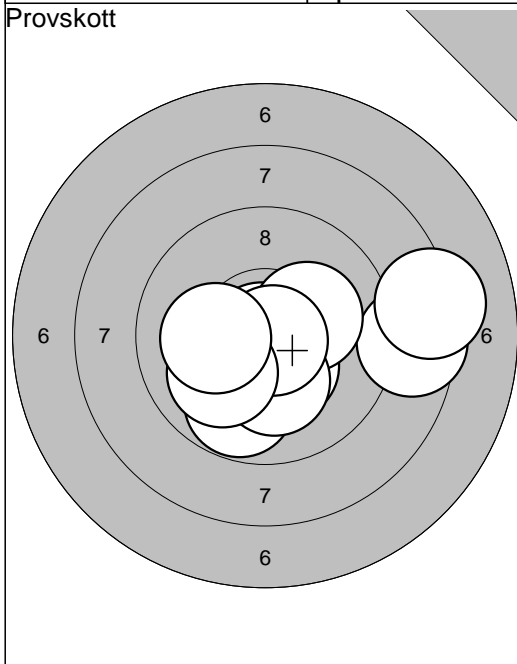

1: 8,6	→
2: 8,2	→
3: 10,9*	↙
4: 10,4*	↘
5: 9,8	↘
6: 10,2*	→
7: 10,2*	↘
8: 10,8*	↘
9: 10,0	↙
10: 10,2*	←
Serie: 95,0	
Summa: 0,0	

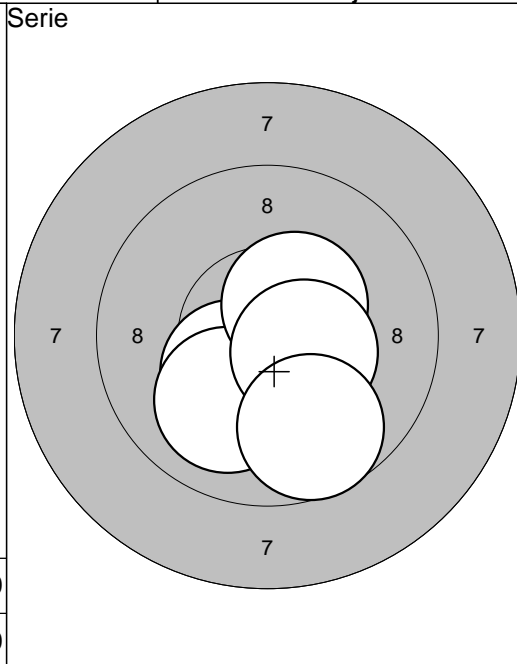

1: 10,3*	↙
2: 10,0	↙
3: 10,4*	↗
4: 10,5*	→
5: 9,7	↘
Serie: 49,0	
Summa: 49,0	

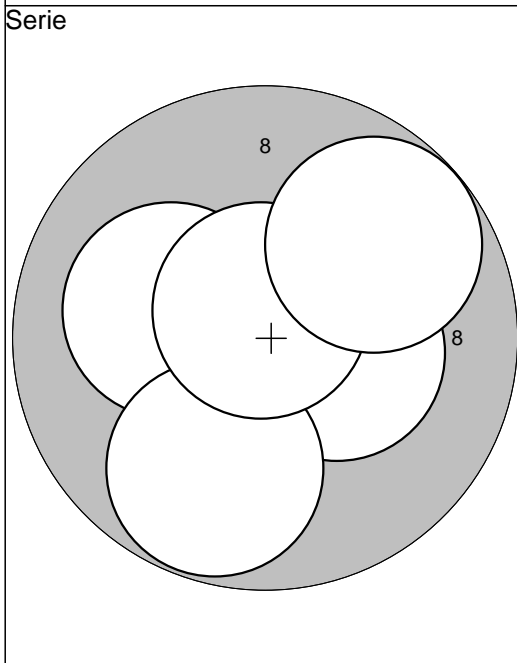

6: 10,3*	→
7: 10,1	←
8: 9,8	↘
9: 10,7*	↑
10: 9,8	↗
Serie: 48,0	
Summa: 97,0	

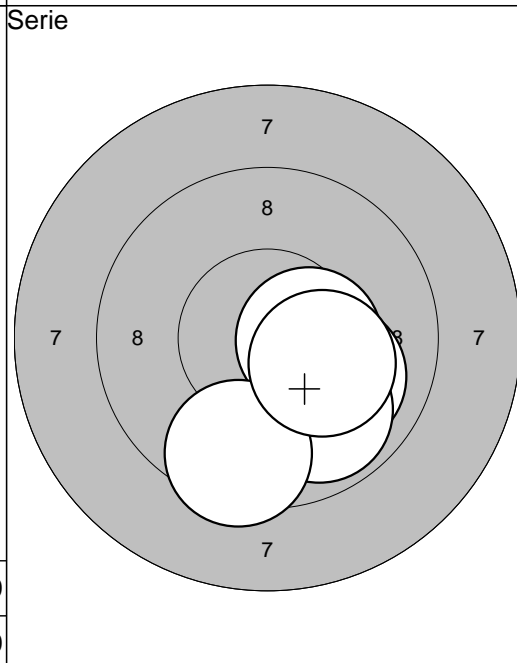

11: 10,4*	→
12: 10,0	↘
13: 9,9	↘
14: 9,5	↘
15: 10,2*	→
Serie: 48,0	
Summa: 145,0	

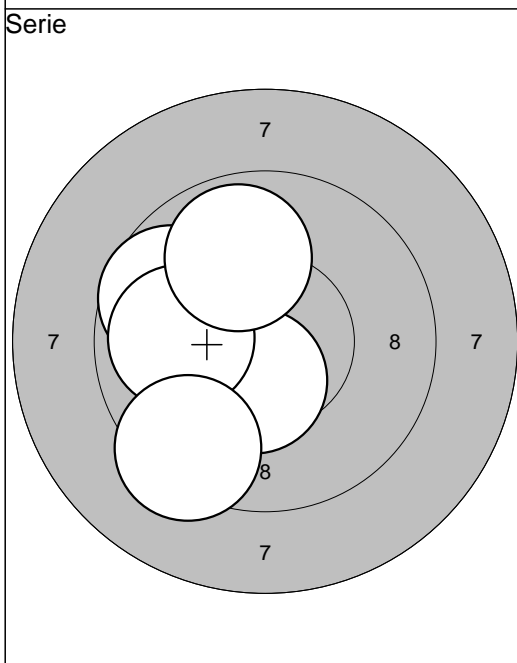

16: 9,7	↙
17: 10,4*	↘
18: 9,9	←
19: 9,9	↑
20: 9,3	↘
Serie: 46,0	
Summa: 191,0	

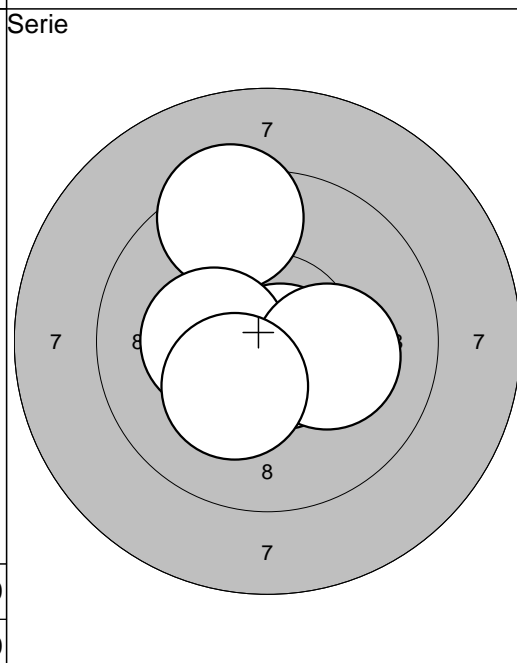

21: 9,4	↑
22: 10,7*	↘
23: 10,3*	←
24: 10,2*	→
25: 10,3*	↘
Serie: 49,0	
Summa: 240,0	



Serie

26: 9,7	↘
27: 9,6	↓
28: 9,4	↓
29: 10,0	→
30: 9,3	↖

Serie: 46,0
Summa: 286,0

Serie

31: 10,2*	↘
32: 10,6*	↑
33: 9,8	↗
34: 9,4	↑
35: 10,1	←

Serie: 48,0
Summa: 334,0

Serie

36: 10,1	↖
37: 10,2*	↖
38: 10,6*	↙
39: 8,8	↑
40: 10,2*	↗

Serie: 48,0
Summa: 382,0

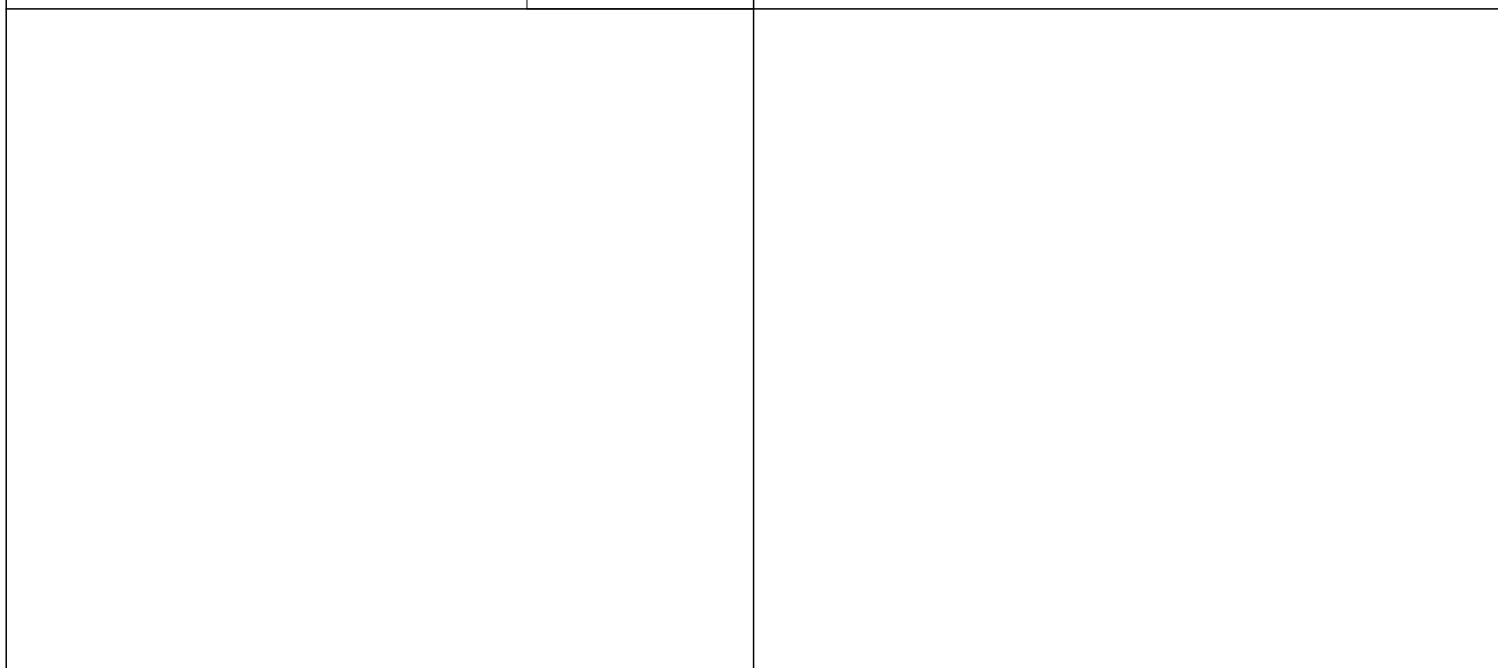

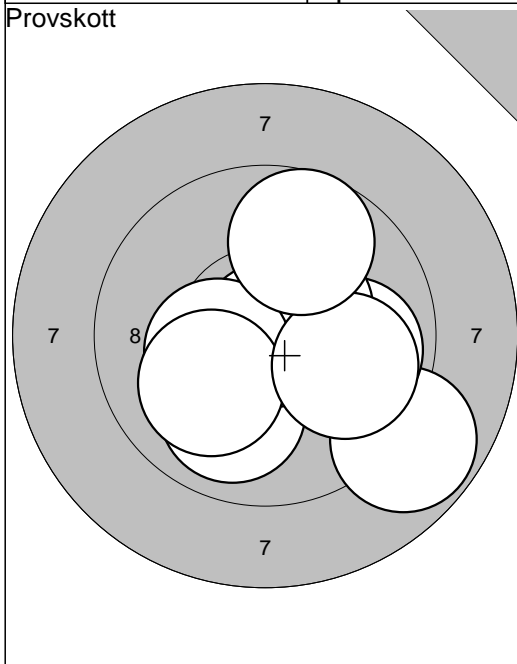

1: 8,8	↘
2: 9,9	→
3: 10,0	↘
4: 10,4*	↗
5: 10,9*	→
6: 10,2*	↙
7: 10,3*	↙
8: 10,1	↙
9: 9,9	→
10: 9,7	↗
<b>Serie: 95,0</b>	
<b>Summa: 0,0</b>	

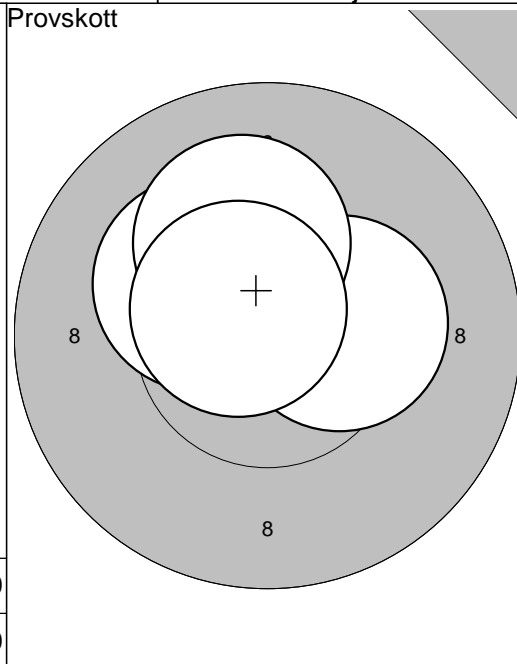

11: 10,3*	→
12: 10,3*	↗
13: 10,2*	↗
14: 10,6*	↗
<b>Serie: 40,0</b>	
<b>Summa: 0,0</b>	

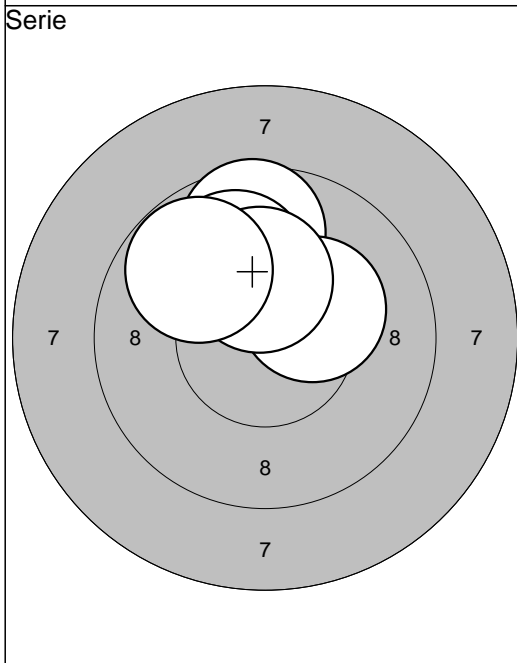

1: 9,7	↗
2: 10,0	↗
3: 10,3*	↗
4: 10,2*	↗
5: 9,8	↙
<b>Serie: 48,0</b>	
<b>Summa: 48,0</b>	

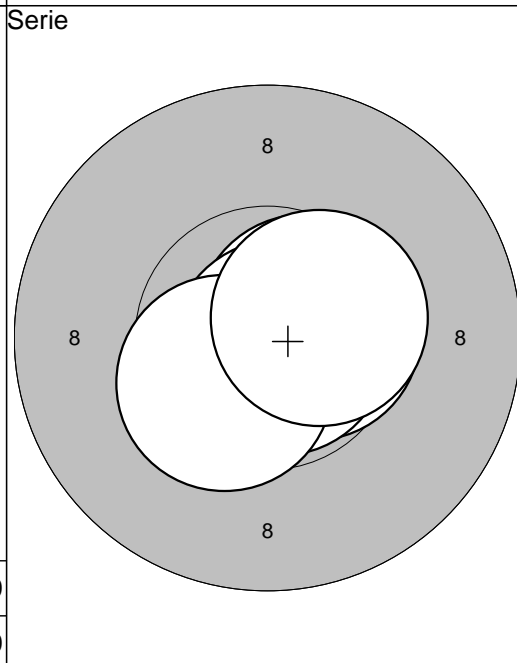

6: 10,6*	↗
7: 10,6*	→
8: 10,8*	↘
9: 10,4*	↘
10: 10,5*	↗
<b>Serie: 50,0</b>	
<b>Summa: 98,0</b>	

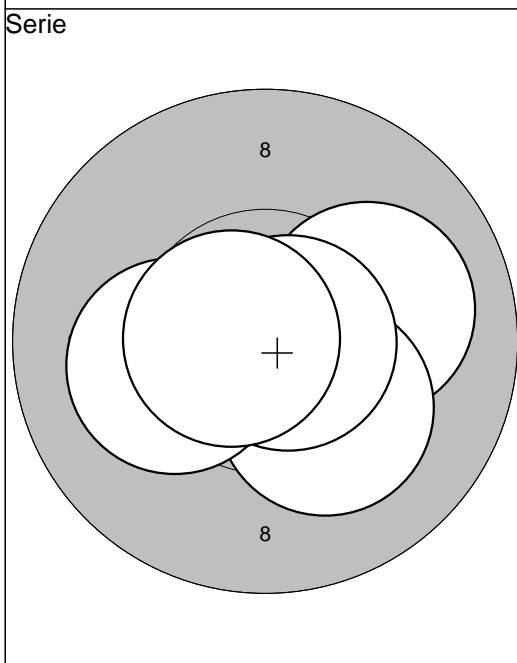

11: 10,1	→
12: 10,2*	↘
13: 10,8*	→
14: 10,2*	↙
15: 10,7*	↙
<b>Serie: 50,0</b>	
<b>Summa: 148,0</b>	

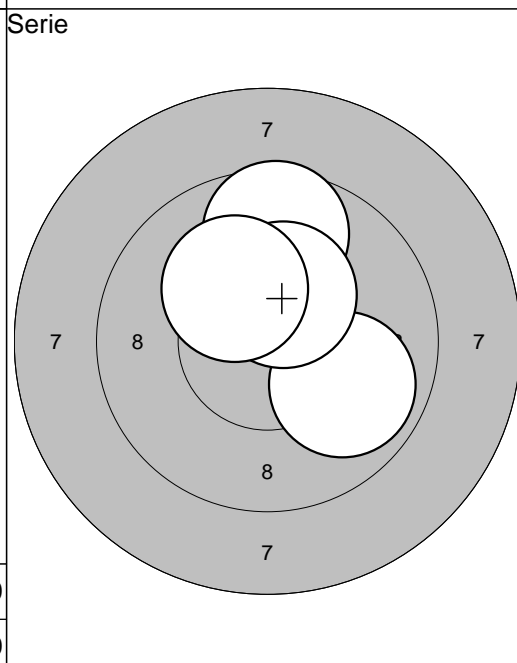

16: 9,9	↘
17: 10,3*	↗
18: 9,6	↗
19: 10,4*	↗
20: 10,2*	↙
<b>Serie: 48,0</b>	
<b>Summa: 196,0</b>	

Serie

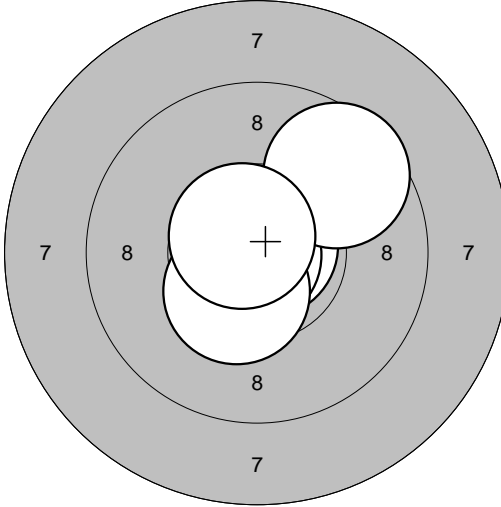

Serie:	49,0
Summa:	245,0

- 21: 10,8\* ↗
- 22: 10,8\* ←
- 23: 10,4\* ↓
- 24: 9,6 →
- 25: 10,7\* ↘

Serie

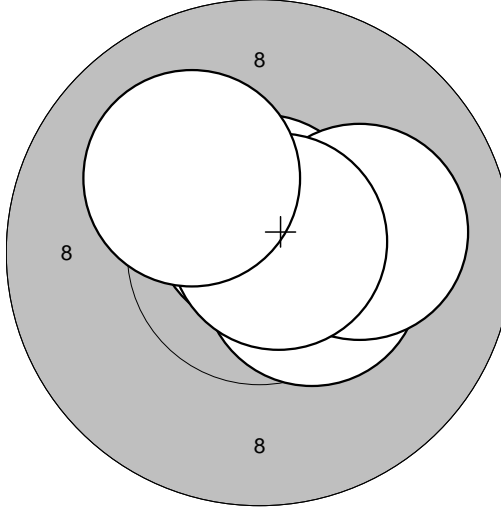

Serie:	50,0
Summa:	295,0

- 26: 10,7\* ↑
- 27: 10,5\* →
- 28: 10,1 →
- 29: 10,8\* →
- 30: 10,1 ↘

Serie

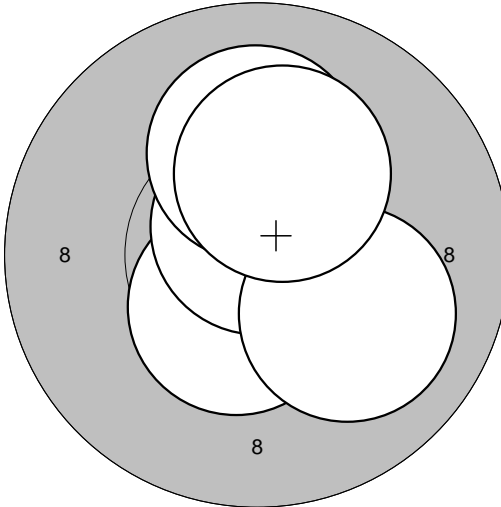

Serie:	50,0
Summa:	345,0

- 31: 10,5\* ↓
- 32: 10,7\* ↑
- 33: 10,1 ↑
- 34: 10,1 →
- 35: 10,2\* ↑

Serie

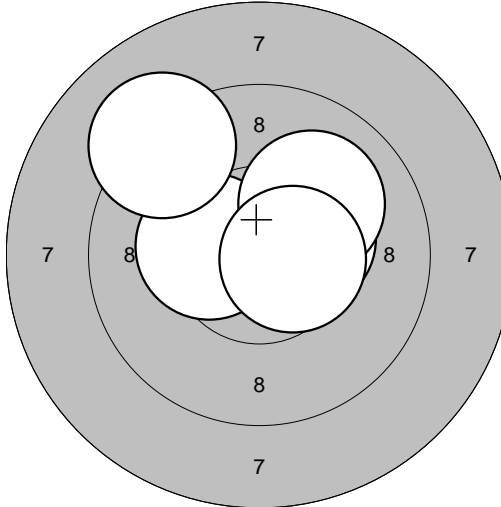

Serie:	49,0
Summa:	394,0

- 36: 10,4\* →
- 37: 10,3\* ←
- 38: 10,1 →
- 39: 9,2 ↗
- 40: 10,5\* →

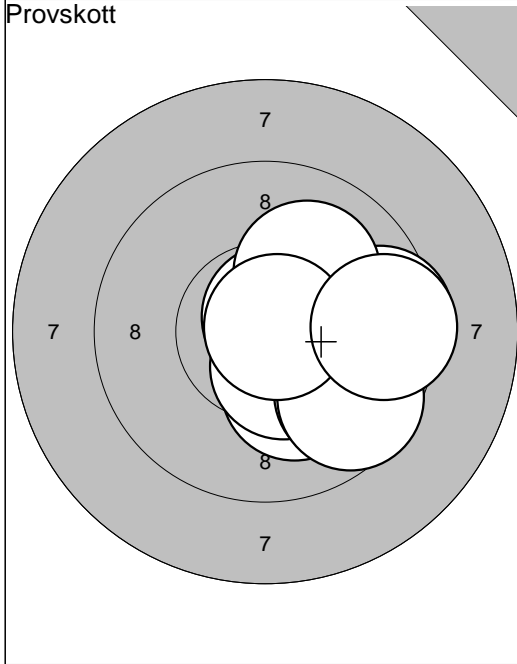

1: 9,5	→
2: 10,7*	↗
3: 10,2*	↘
4: 10,3*	↗
5: 10,5*	↘
6: 9,7	↘
7: 9,6	↘
8: 10,1	↗
9: 10,8*	→
10: 9,5	→
<b>Serie: 96,0</b>	
<b>Summa: 0,0</b>	

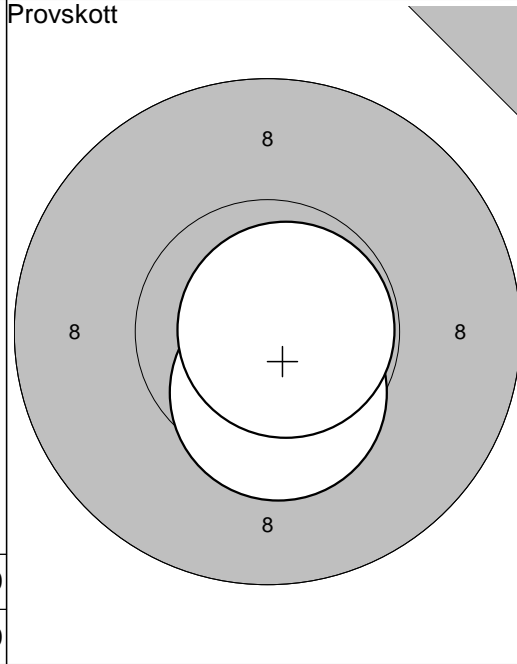

11: 10,4*	↘
12: 10,8*	→
<b>Serie: 20,0</b>	
<b>Summa: 0,0</b>	

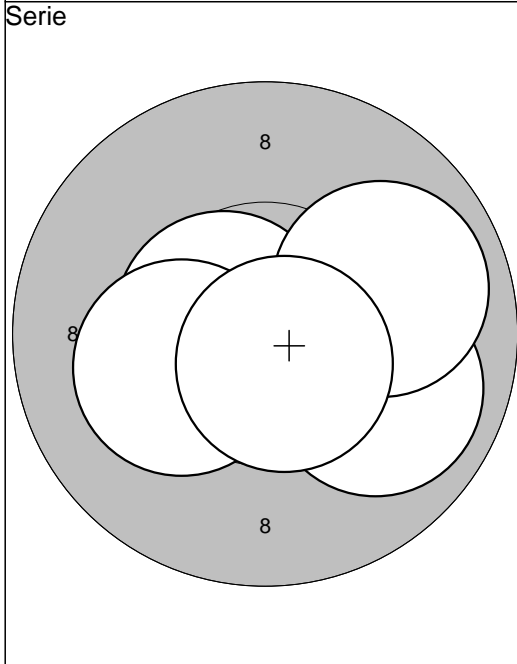

1: 10,6*	↖
2: 9,9	↘
3: 10,2*	↖
4: 9,9	↗
5: 10,7*	↘
<b>Serie: 48,0</b>	
<b>Summa: 48,0</b>	

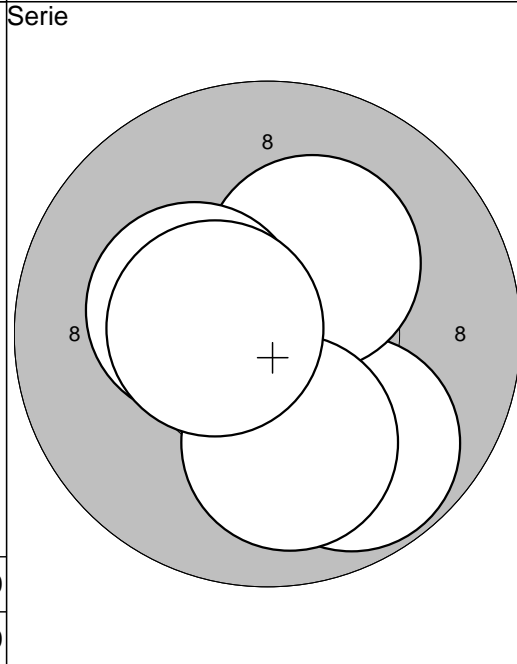

6: 9,8	↘
7: 10,3*	↗
8: 10,3*	↖
9: 10,0	↘
10: 10,5*	↖
<b>Serie: 49,0</b>	
<b>Summa: 97,0</b>	

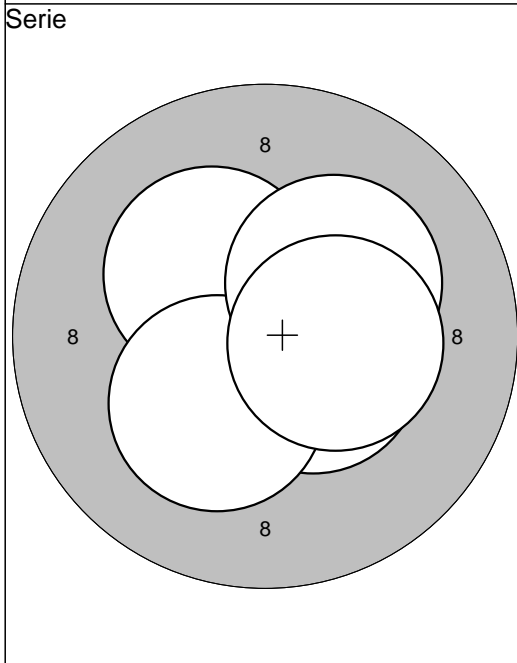

11: 10,5*	↘
12: 10,3*	↗
13: 10,3*	↘
14: 10,2*	↗
15: 10,4*	→
<b>Serie: 50,0</b>	
<b>Summa: 147,0</b>	

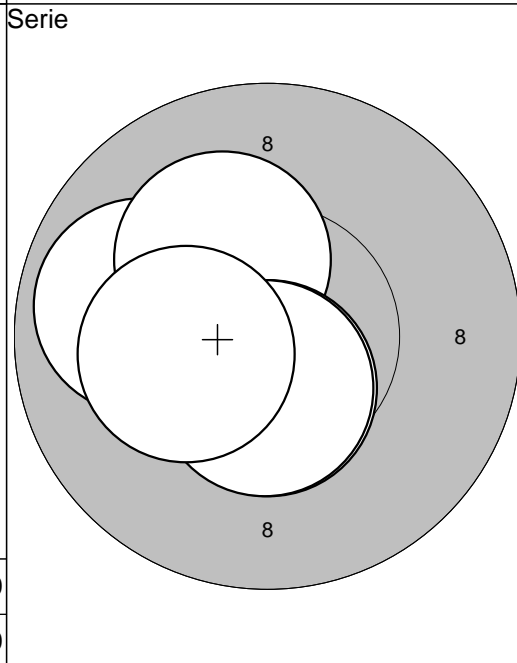

16: 9,9	↖
17: 10,2*	↗
18: 10,5*	↘
19: 10,5*	↘
20: 10,3*	↖
<b>Serie: 49,0</b>	
<b>Summa: 196,0</b>	

Serie

21: 10,4*	↑
22: 10,3*	↗
23: 10,4*	↘
24: 10,2*	↓
25: 10,1	↘
<b>Serie: 50,0</b>	
<b>Summa: 246,0</b>	

Serie

26: 10,7*	↗
27: 10,5*	↘
28: 10,1	↓
29: 10,3*	↘
30: 10,4*	↘
<b>Serie: 50,0</b>	
<b>Summa: 296,0</b>	

Serie

31: 10,0	↙
32: 10,8*	↘
33: 9,6	↙
34: 10,1	→
35: 10,7*	↘
<b>Serie: 49,0</b>	
<b>Summa: 345,0</b>	

Serie

36: 10,9*	↗
37: 9,4	↘
38: 10,8*	→
39: 10,5*	↑
40: 10,2*	↗
<b>Serie: 49,0</b>	
<b>Summa: 394,0</b>	

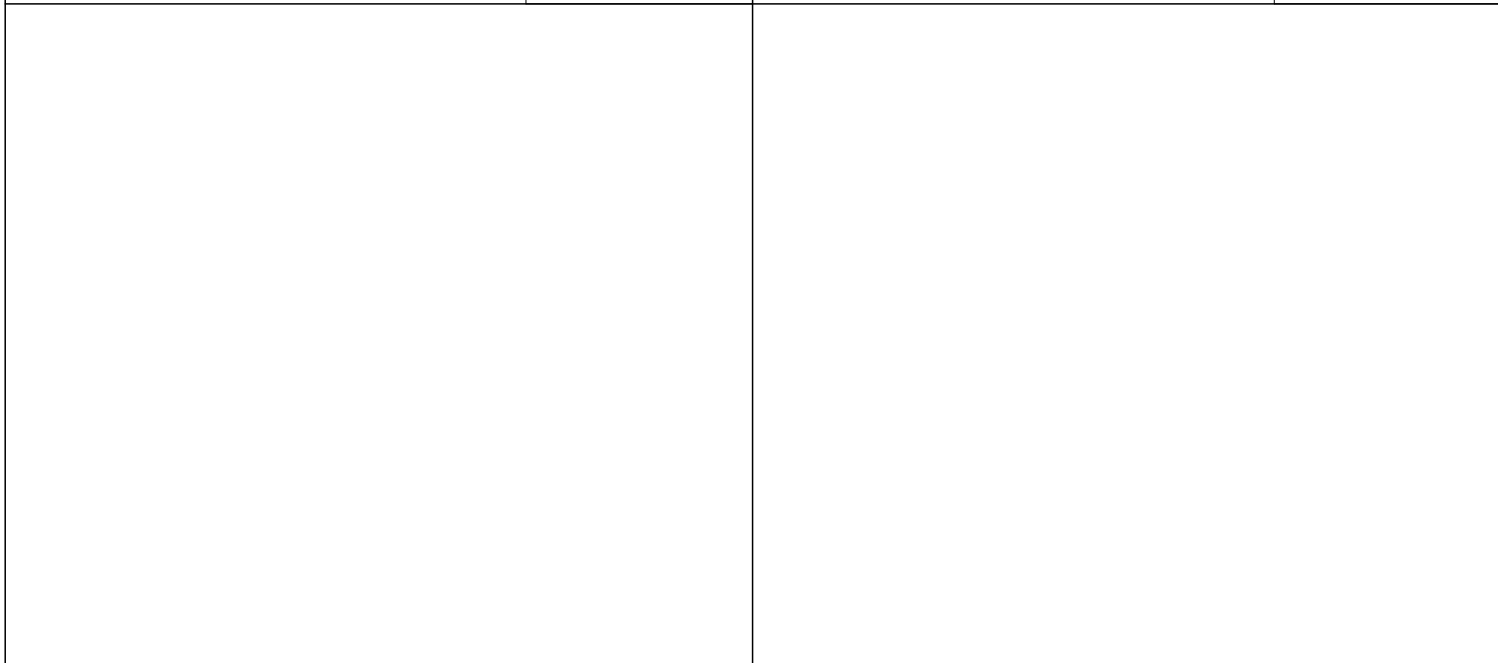

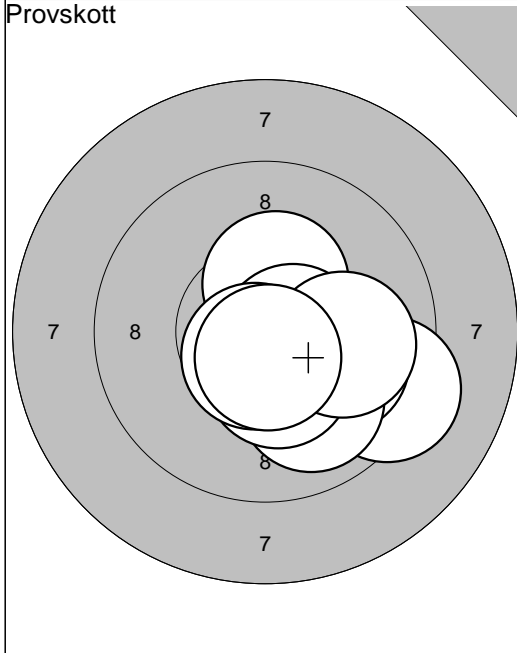

1: 9,9	↘
2: 9,3	→
3: 10,4*	↑
4: 10,6*	→
5: 10,0	→
6: 9,9	↘
7: 10,4*	↘
8: 10,0	→
9: 10,6*	↘
10: 10,6*	↘
<b>Serie: 97,0</b>	
<b>Summa: 0,0</b>	

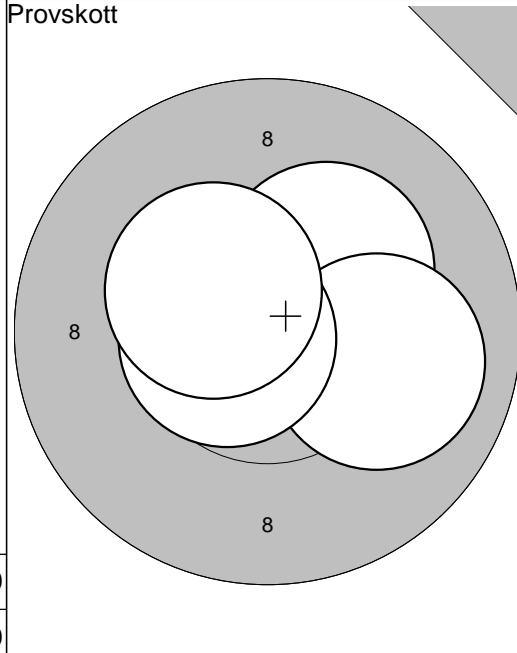

11: 10,2*	↗
12: 10,0	→
13: 10,6*	←
14: 10,4*	↖
<b>Serie: 40,0</b>	
<b>Summa: 0,0</b>	

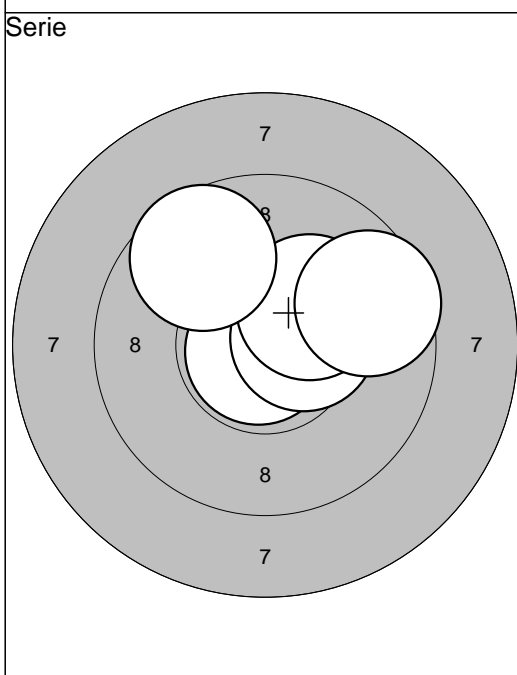

1: 10,8*	↙
2: 10,5*	→
3: 10,2*	↗
4: 9,7	↖
5: 9,6	→
<b>Serie: 48,0</b>	
<b>Summa: 48,0</b>	

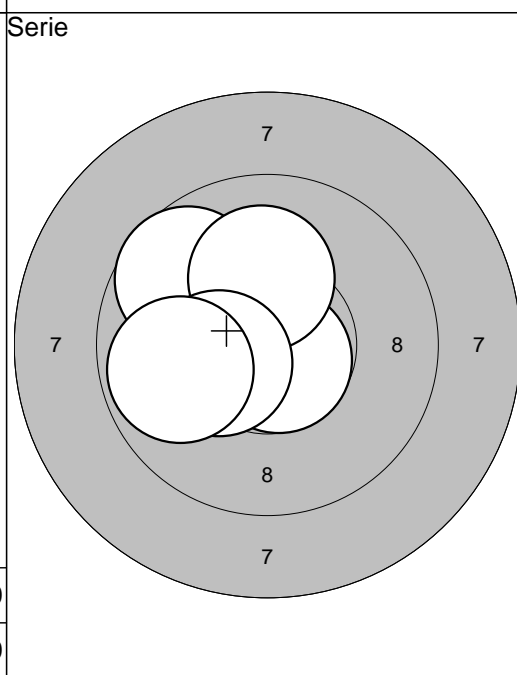

6: 9,7	↖
7: 10,7*	↘
8: 10,1	↑
9: 10,3*	←
10: 9,8	←
<b>Serie: 48,0</b>	
<b>Summa: 96,0</b>	

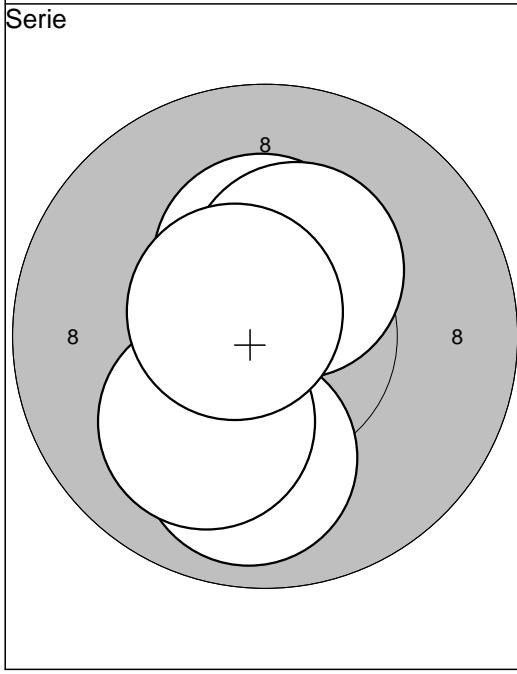

11: 9,9	↓
12: 10,3*	↑
13: 10,1	↘
14: 10,3*	↗
15: 10,6*	↖
<b>Serie: 49,0</b>	
<b>Summa: 145,0</b>	

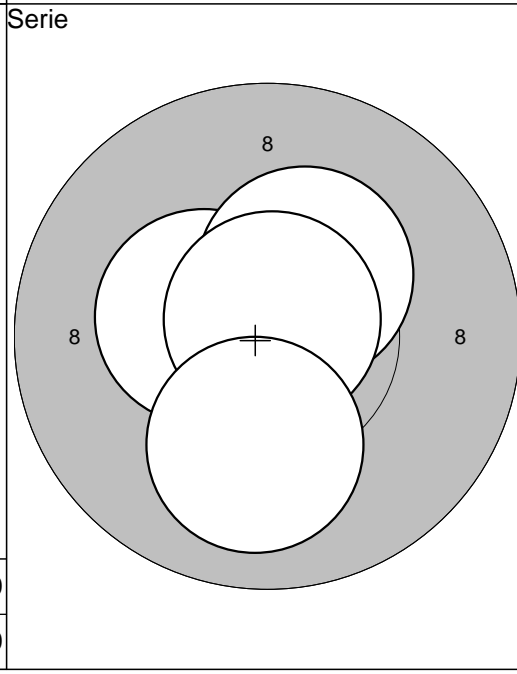

16: 10,7*	←
17: 10,4*	←
18: 10,4*	↗
19: 10,8*	↗
20: 10,0	↓
<b>Serie: 50,0</b>	
<b>Summa: 195,0</b>	

Serie

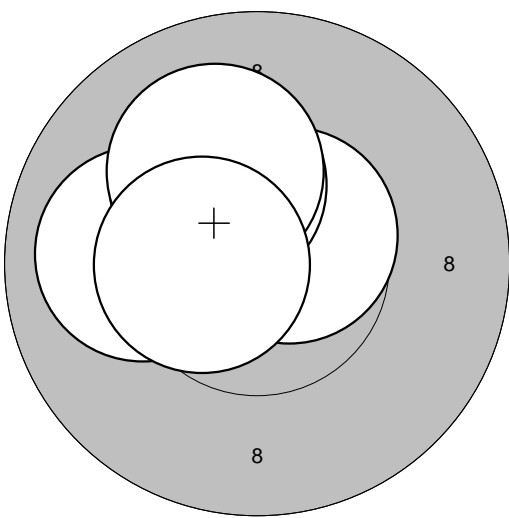

Serie:	50,0
Summa:	245,0

Serie

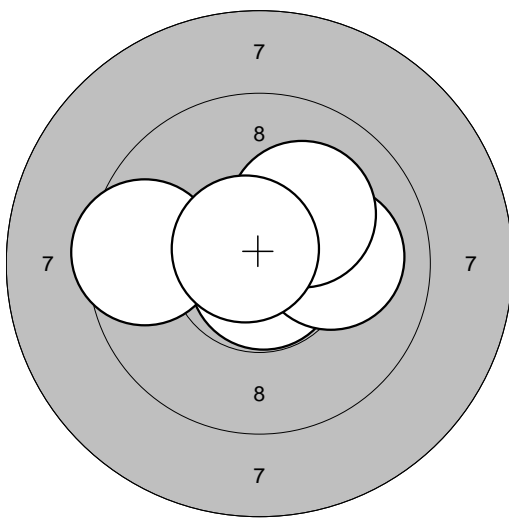

Serie:	49,0
Summa:	294,0

Serie

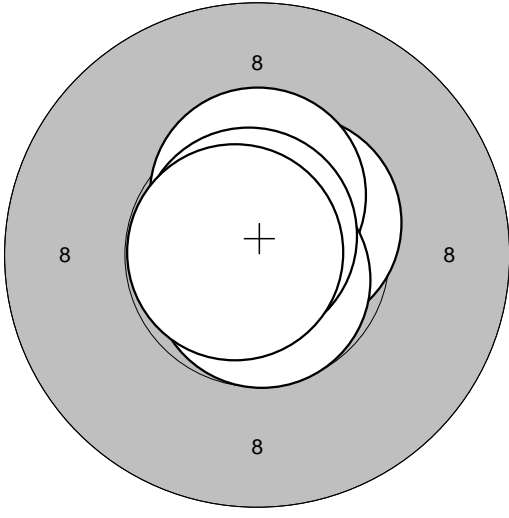

Serie:	50,0
Summa:	344,0

Serie

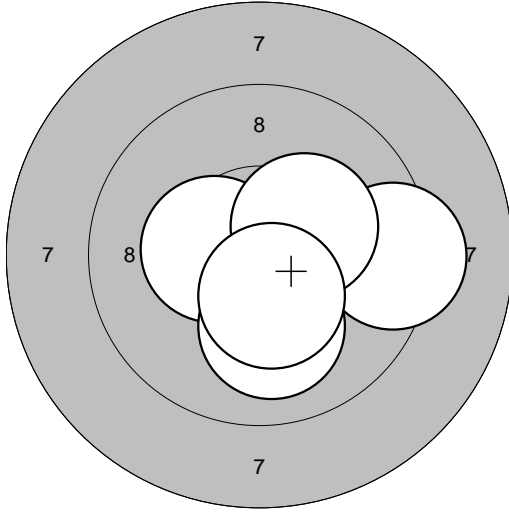

Serie:	49,0
Summa:	393,0

--	--

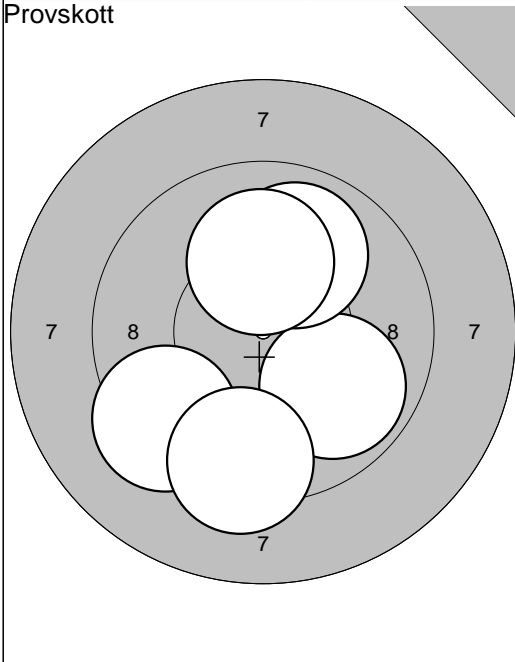

- 1: 9,3 ↙
- 2: 9,9 ↘
- 3: 9,9 ↗
- 4: 10,1 ↑
- 5: 9,3 ↓

Serie: 46,0  
Summa: 0,0

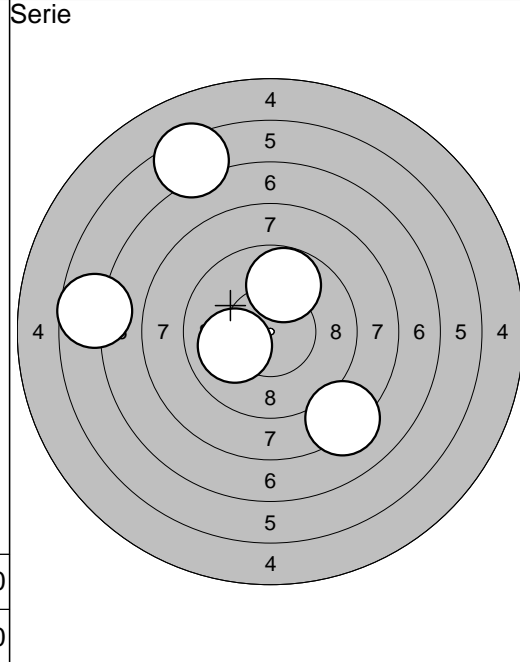

- 1: 6,4 ↗
- 2: 9,8 ↗
- 3: 10,0 ←
- 4: 6,7 ←
- 5: 8,2 ↘

Serie: 39,0  
Summa: 39,0

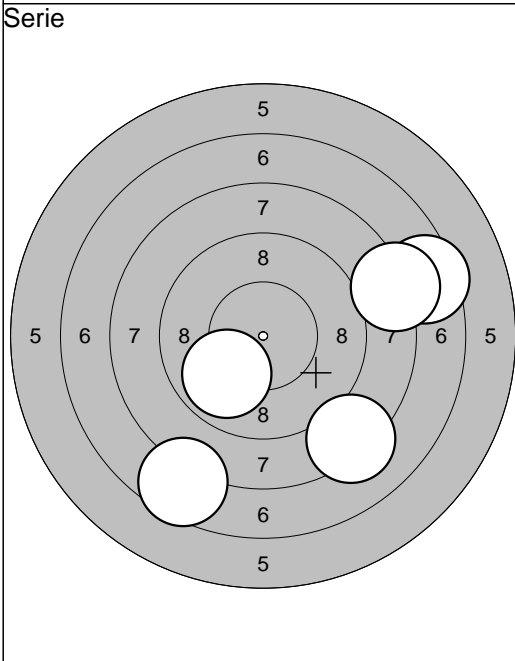

- 6: 8,2 ↘
- 7: 7,5 →
- 8: 9,9 ↘
- 9: 8,1 →
- 10: 7,6 ↘

Serie: 39,0  
Summa: 78,0

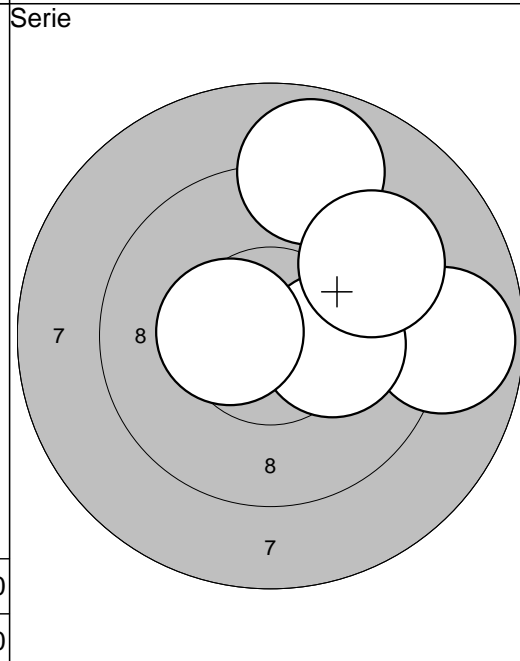

- 11: 8,8 →
- 12: 8,9 ↗
- 13: 10,2\* →
- 14: 9,4 ↗
- 15: 10,5\* ←

Serie: 45,0  
Summa: 123,0

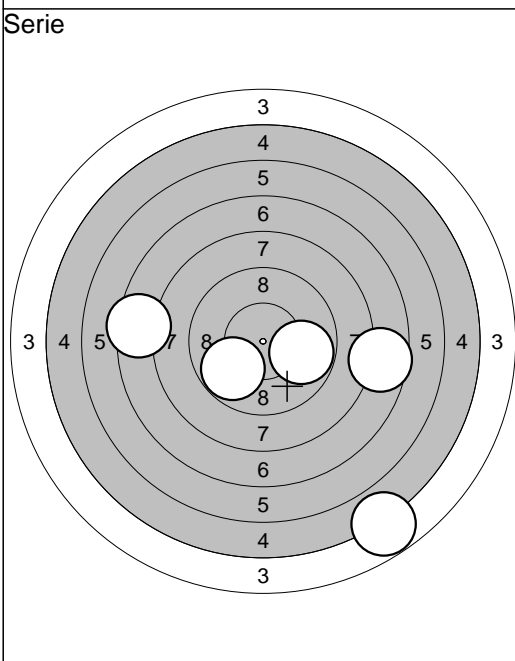

- 16: 4,8 ↘
- 17: 7,6 →
- 18: 9,8 →
- 19: 9,8 ↘
- 20: 7,4 ←

Serie: 36,0  
Summa: 159,0

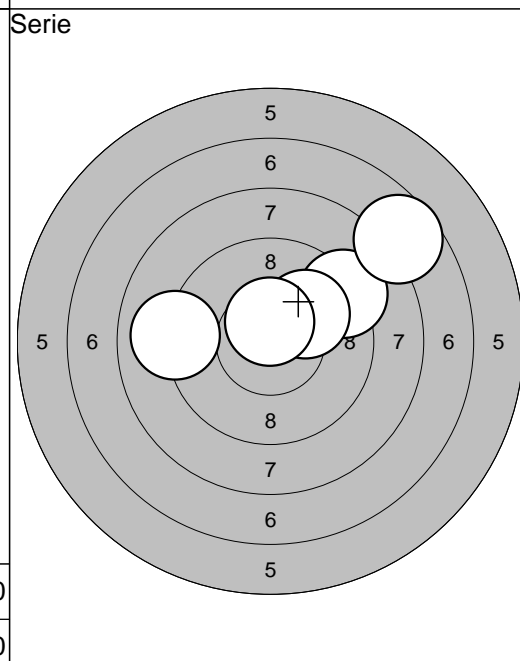

- 21: 9,0 ←
- 22: 9,2 ↗
- 23: 10,1 ↗
- 24: 10,6\* ↑
- 25: 7,7 ↗

Serie: 45,0  
Summa: 204,0



