

1: 10,1 ↗
2: 9,8 ↑
3: 10,6* →
4: 10,7* →
5: 10,1 ↗
6: 10,1 ↓
7: 10,6* ←
8: 10,8* ↓
9: 10,8* ↗
Serie: 89,0
Summa: 0,0

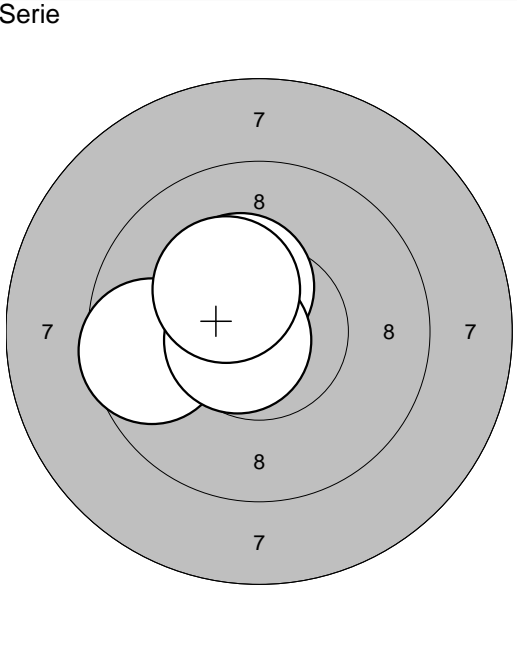

1: 10,4* ↗
2: 10,5* ←
3: 9,6 ←
4: 10,7* ←
5: 10,3* ↗
Serie: 49,0
Summa: 49,0

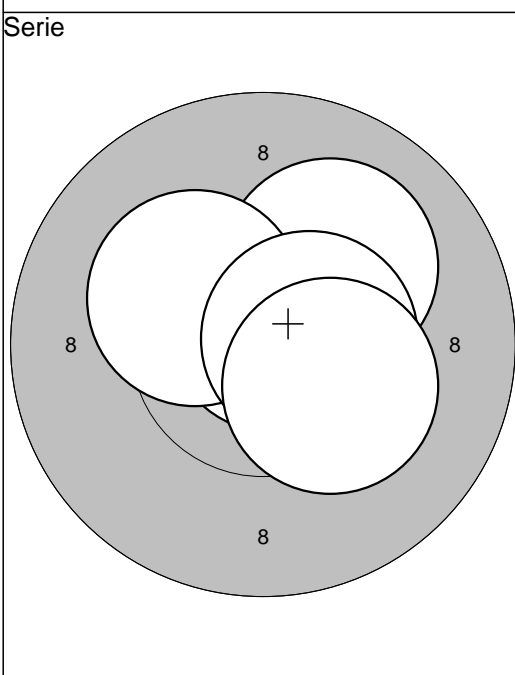

6: 10,8* ↗
7: 10,1 ↗
8: 10,3* ↖
9: 10,6* →
10: 10,3* ↘
Serie: 50,0
Summa: 99,0

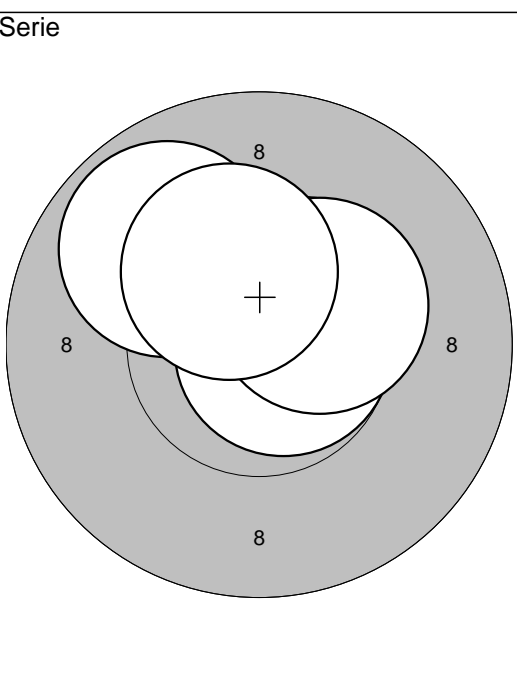

11: 10,5* ↗
12: 10,7* →
13: 9,9 ↖
14: 10,4* ↗
15: 10,3* ↗
Serie: 49,0
Summa: 148,0

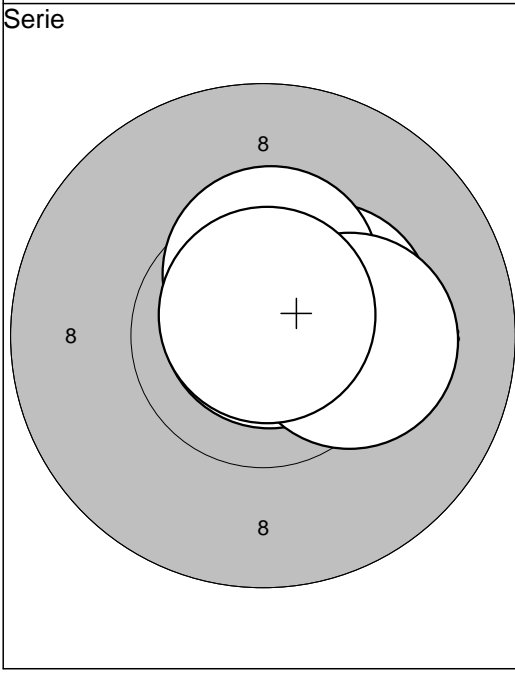

16: 10,4* →
17: 10,8* ↗
18: 10,4* ↑
19: 10,2* →
20: 10,8* ↑
Serie: 50,0
Summa: 198,0

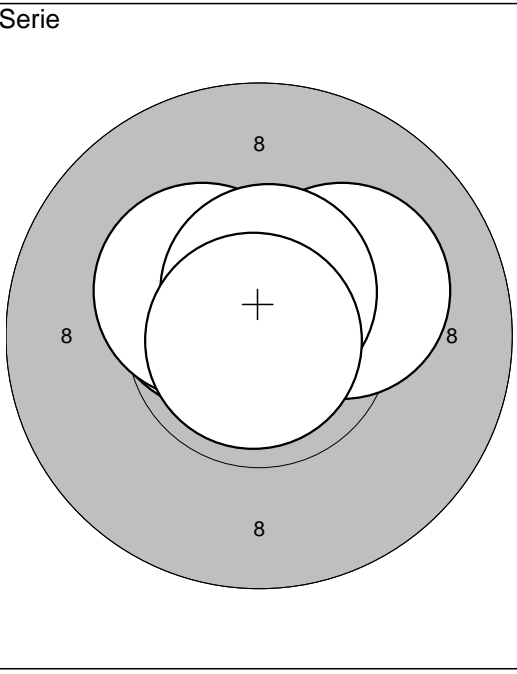

21: 10,2* ↗
22: 10,5* ↖
23: 10,4* ↖
24: 10,6* ↑
25: 10,9* ↘
Serie: 50,0
Summa: 248,0

Serie

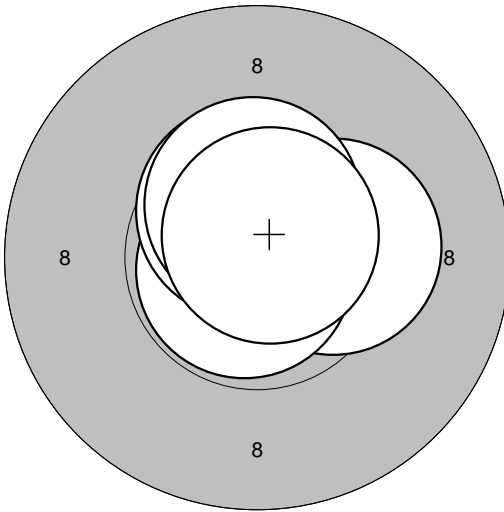

Serie: 50,0	
Summa: 298,0	

- 26: 10,3* →
- 27: 10,8* ↙
- 28: 10,6* ↑
- 29: 10,5* ↑
- 30: 10,7* ↗

Serie

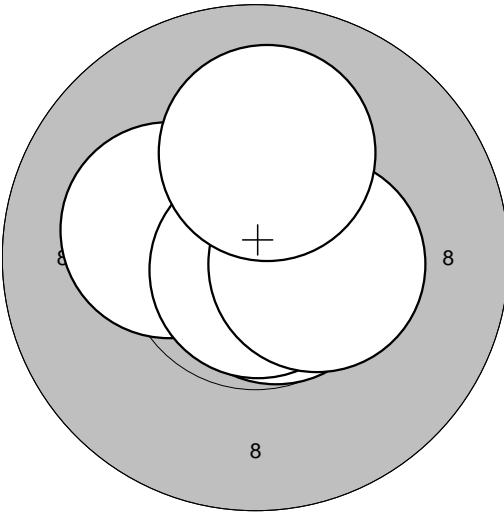

Serie: 50,0	
Summa: 348,0	

- 31: 10,2* ←
- 32: 10,7* ↘
- 33: 10,8* ↓
- 34: 10,4* →
- 35: 10,1 ↑

Serie

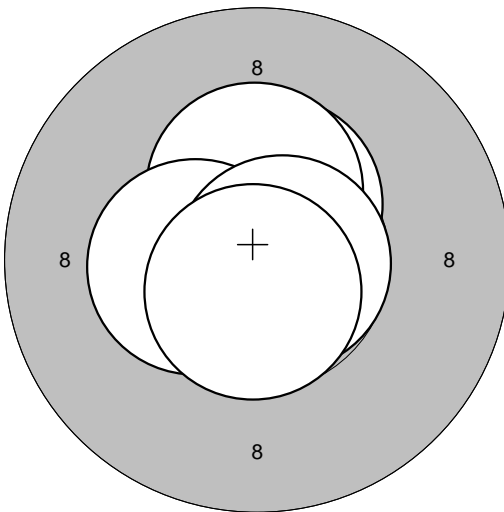

Serie: 50,0	
Summa: 398,0	

- 36: 10,5* ↗
- 37: 10,4* ↑
- 38: 10,4* ←
- 39: 10,7* →
- 40: 10,7* ↓

Serie

Serie: 50,0	
Summa: 398,0	

Empty space for additional notes or scores.

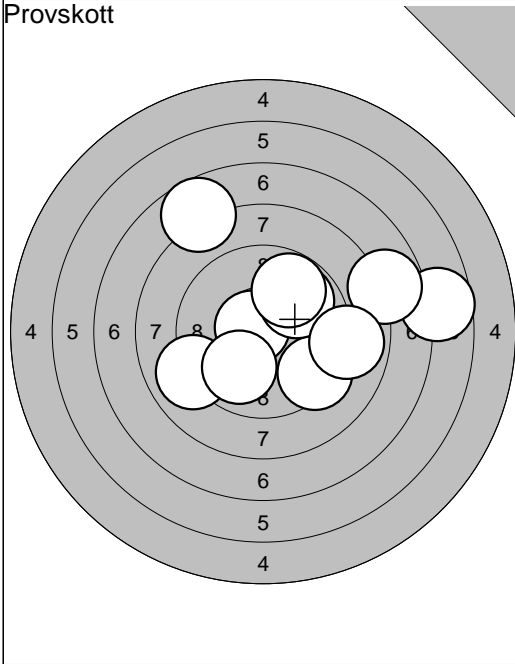

1: 6,7	→
2: 9,0	←
3: 9,3	↘
4: 10,7*	←
5: 9,9	↗
6: 9,8	↗
7: 9,9	↘
8: 7,8	→
9: 7,7	↖
10: 8,9	→
Serie: 83,0	
Summa: 0,0	

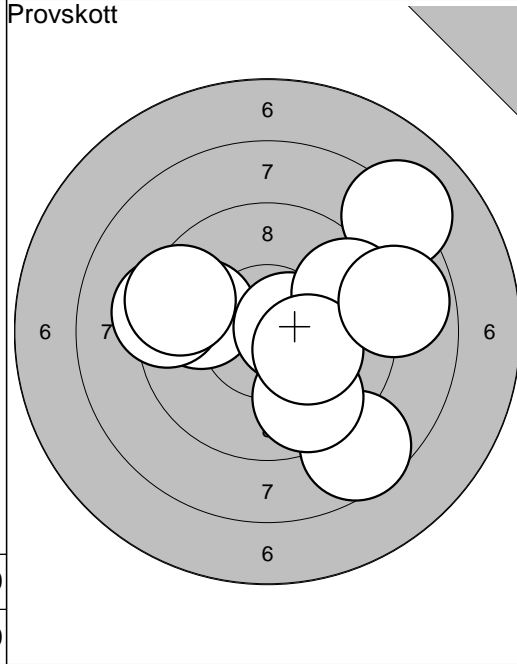

11: 9,8	←
12: 10,6*	→
13: 8,1	↗
14: 9,5	→
15: 8,6	↘
16: 9,7	↘
17: 10,2*	→
18: 9,3	←
19: 8,8	→
20: 9,5	←
Serie: 89,0	
Summa: 0,0	

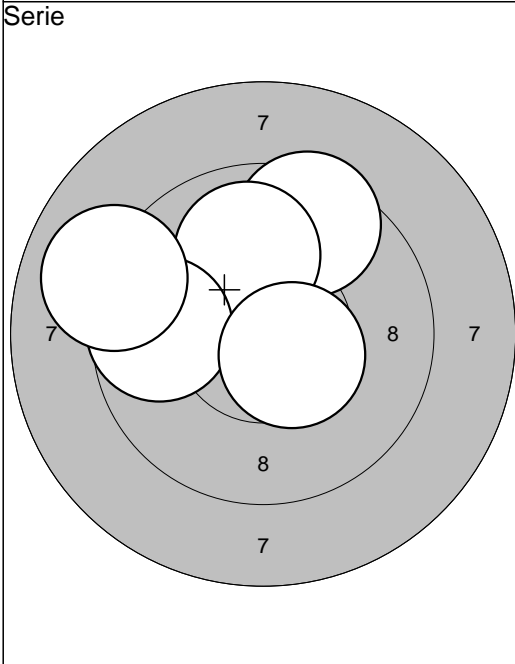

1: 9,5	↗
2: 10,0	↑
3: 9,7	←
4: 10,5*	↘
5: 9,0	←
Serie: 47,0	
Summa: 47,0	

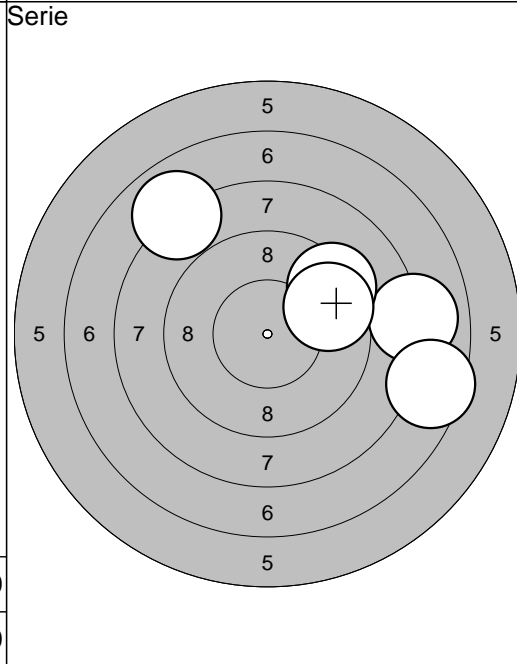

6: 8,0	↖
7: 8,0	→
8: 9,4	↗
9: 7,5	→
10: 9,6	↗
Serie: 41,0	
Summa: 88,0	

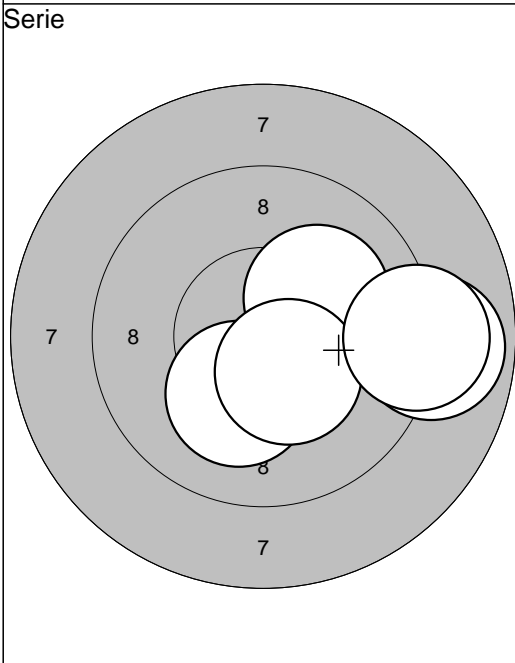

11: 10,2*	↘
12: 10,1	↗
13: 8,9	→
14: 10,4*	↘
15: 9,1	→
Serie: 47,0	
Summa: 135,0	

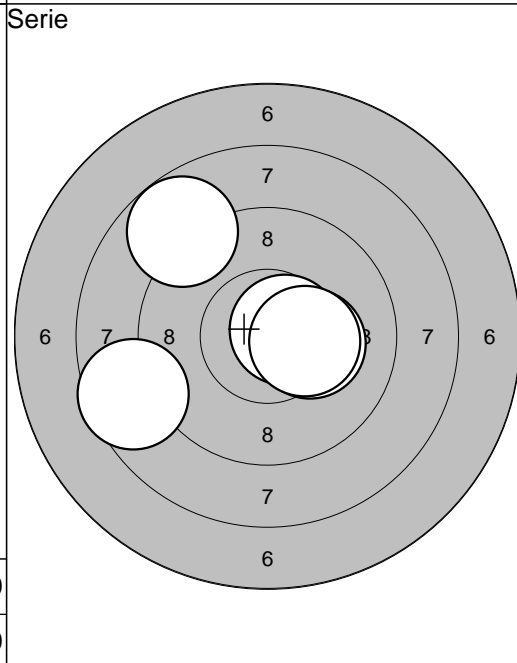

16: 10,6*	→
17: 10,2*	→
18: 8,6	←
19: 8,8	↗
20: 10,3*	→
Serie: 46,0	
Summa: 181,0	

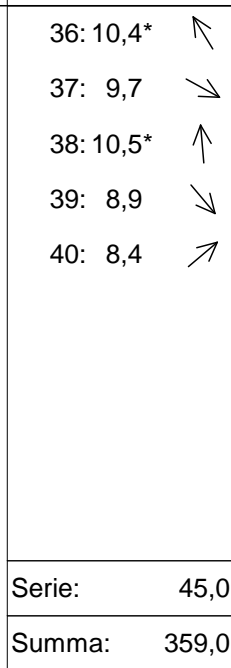
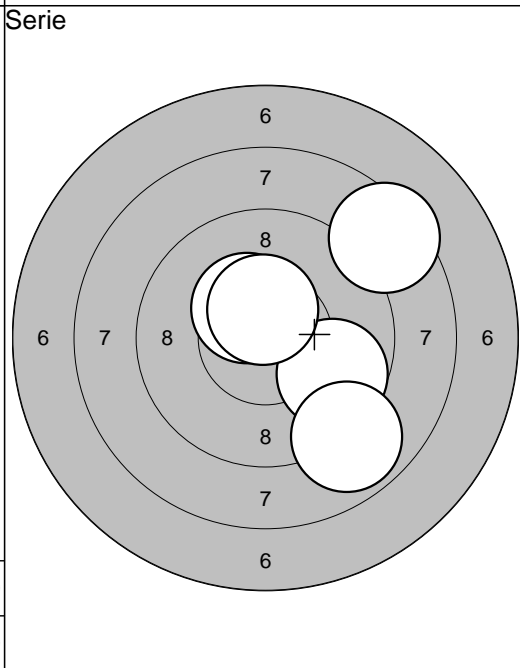
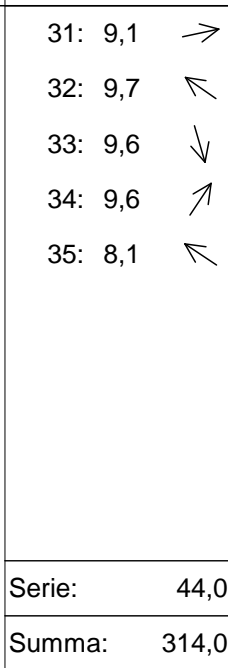
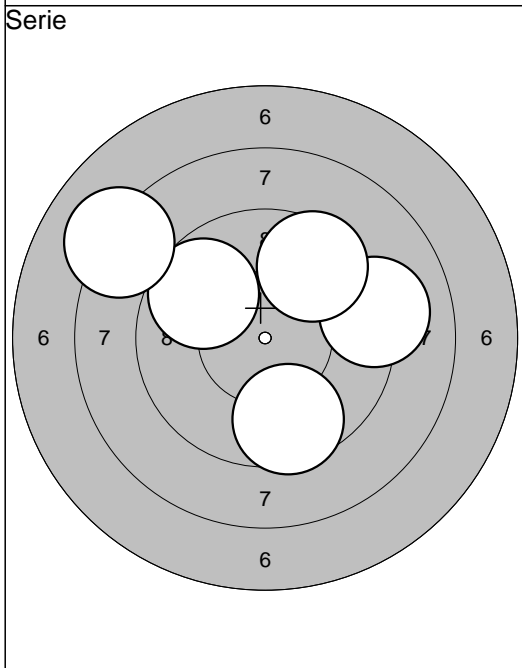
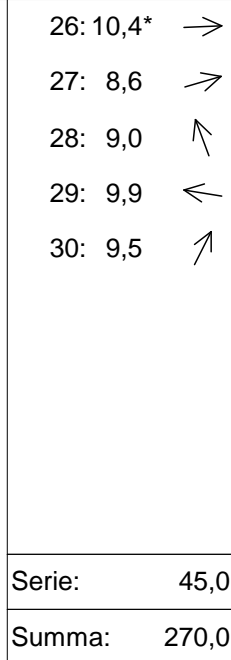
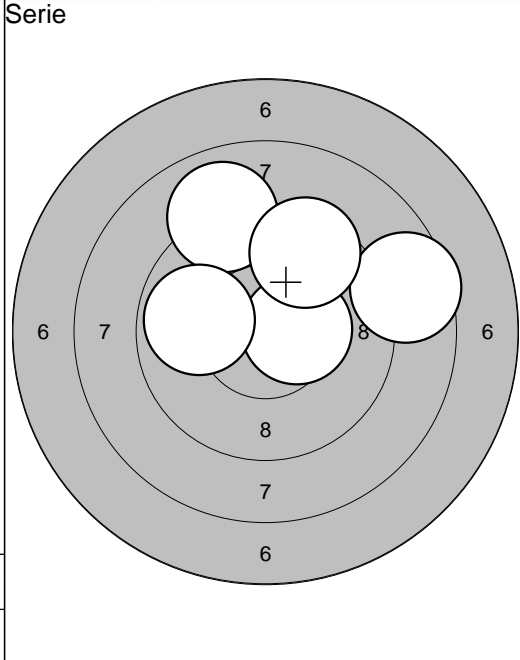
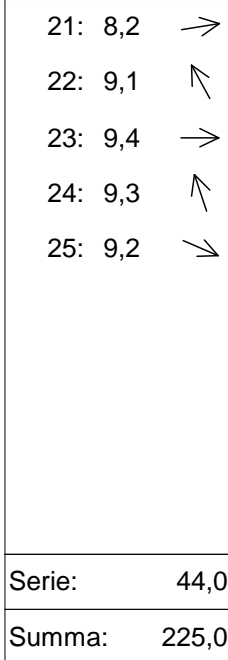
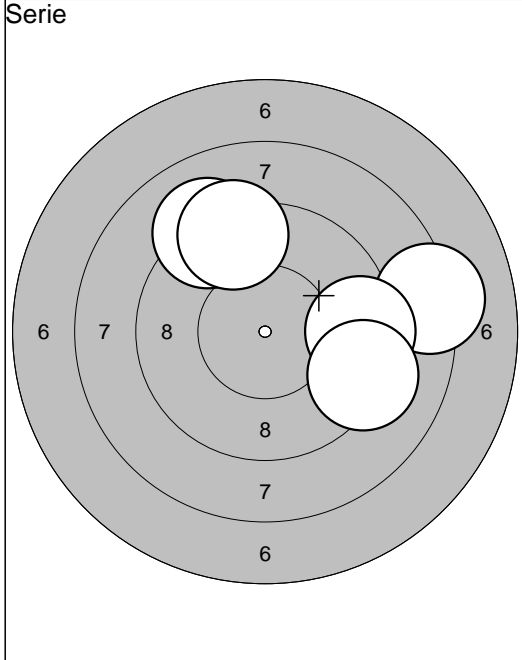

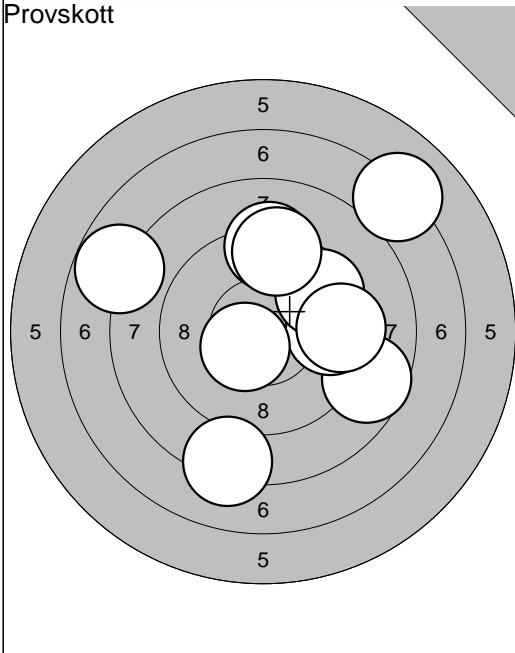

Serie

1: 7,1	↗
2: 8,6	→
3: 9,6	→
4: 10,5*	↙
5: 7,8	↖
6: 8,2	↓
7: 9,2	↑
8: 9,6	↗
9: 9,3	↑
10: 9,4	→
<hr/>	
Serie:	85,0
Summa:	0,0

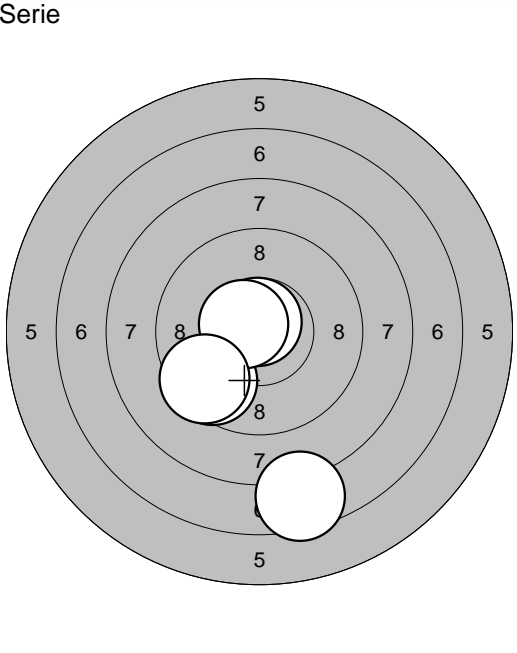

Serie

1: 10,8*	↑
2: 7,5	↓
3: 9,6	↘
4: 10,6*	↖
5: 9,5	↙
<hr/>	
Serie:	45,0
Summa:	45,0

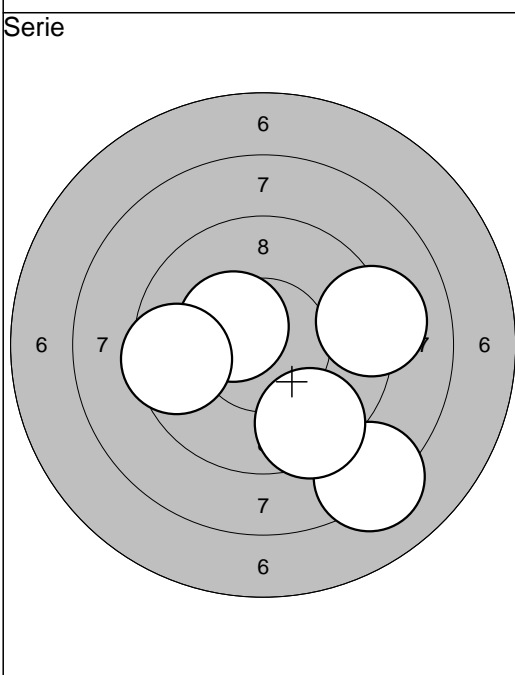

Serie

6: 9,1	→
7: 8,2	↘
8: 10,4*	↖
9: 9,5	↖
10: 9,5	↘
<hr/>	
Serie:	45,0
Summa:	90,0

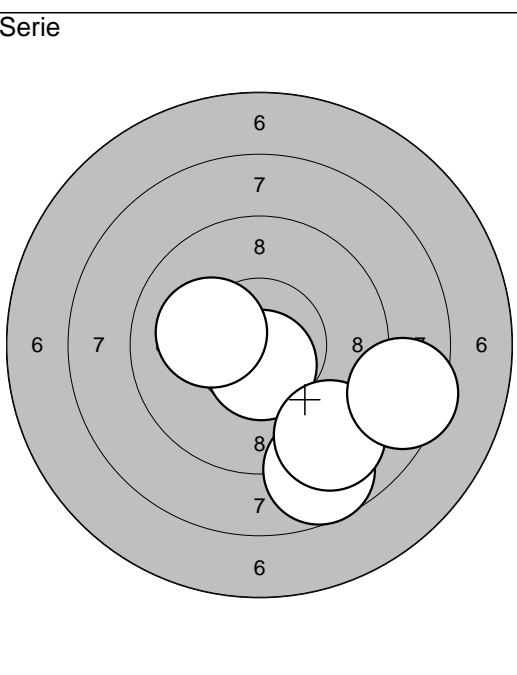

Serie

11: 10,6*	↓
12: 8,7	↘
13: 9,1	↘
14: 8,5	→
15: 10,2*	↖
<hr/>	
Serie:	45,0
Summa:	135,0

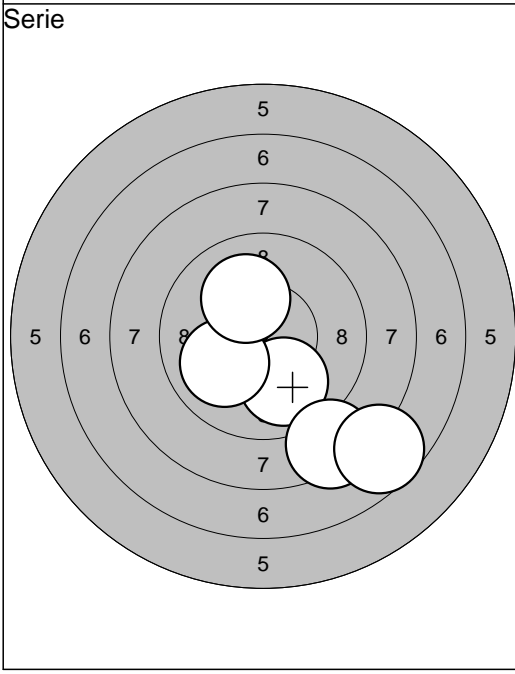

Serie

16: 9,9	↓
17: 8,4	↓
18: 7,7	↘
19: 10,0	↖
20: 10,1	↗
<hr/>	
Serie:	44,0
Summa:	179,0

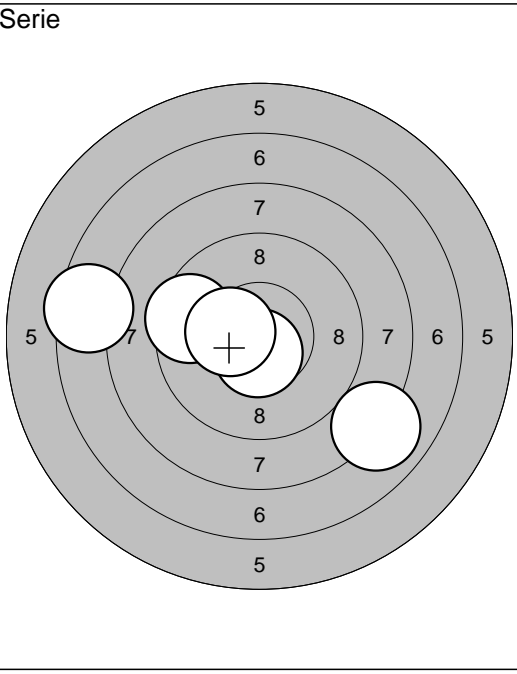

Serie

21: 9,5	↖
22: 10,6*	↓
23: 7,5	↖
24: 10,4*	↖
25: 8,0	↘
<hr/>	
Serie:	44,0
Summa:	223,0

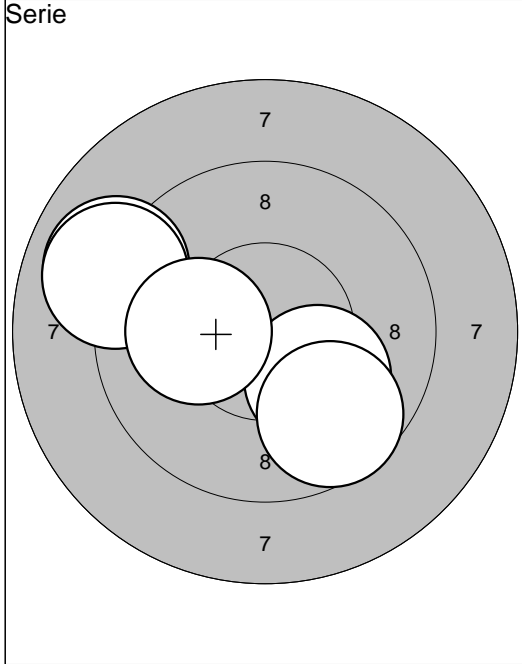

26: 9,0	↙
27: 9,0	↙
28: 10,1	↘
29: 9,7	↘
30: 10,1	↙
<hr/>	
Serie:	47,0
Summa:	270,0

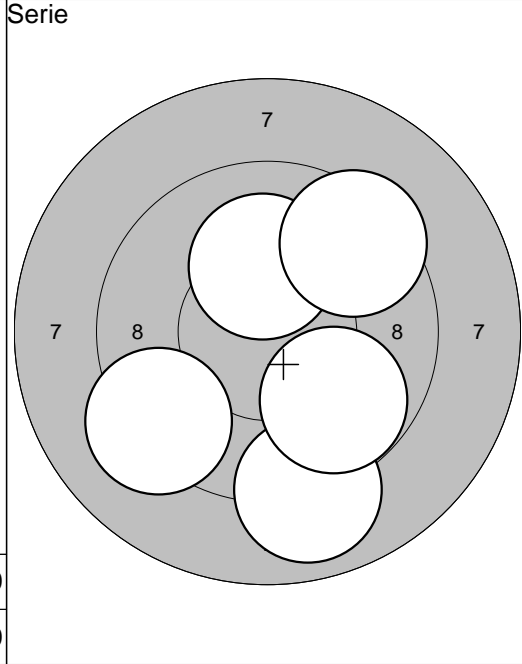

31: 8,9	↓
32: 9,2	↙
33: 10,2*	↑
34: 9,8	↘
35: 9,4	↗
<hr/>	
Serie:	45,0
Summa:	315,0

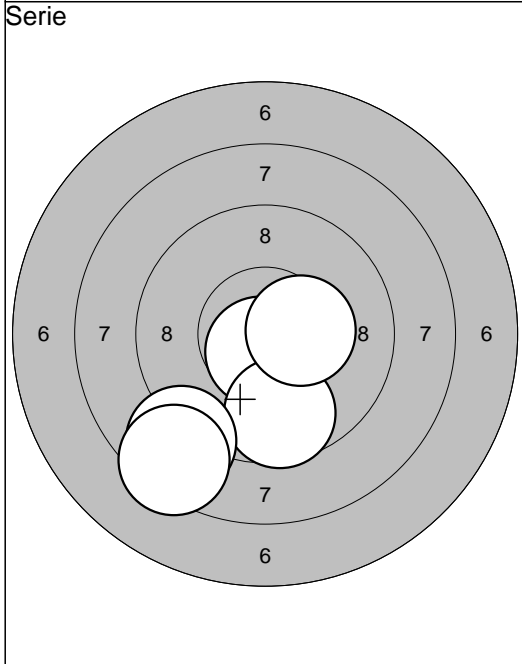

36: 10,6*	↓
37: 9,6	↓
38: 8,7	↙
39: 10,4*	→
40: 8,4	↙
<hr/>	
Serie:	45,0
Summa:	360,0

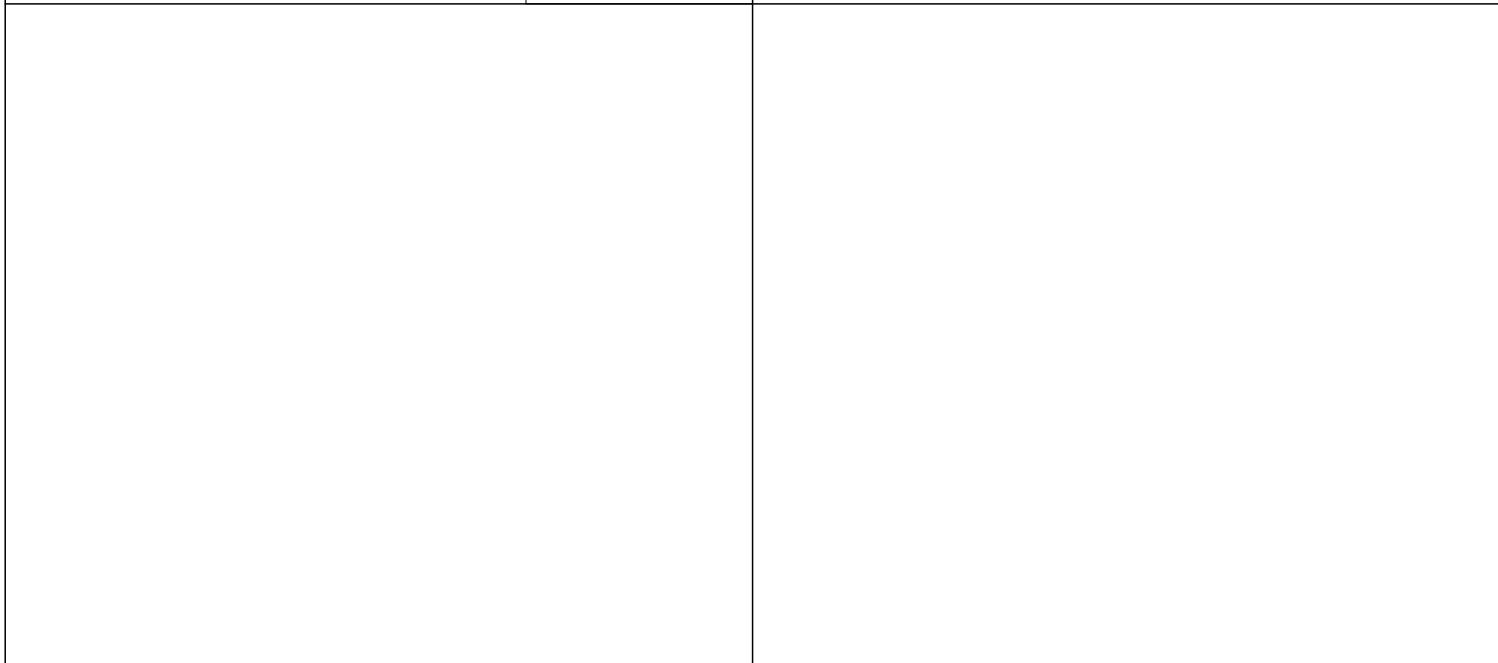

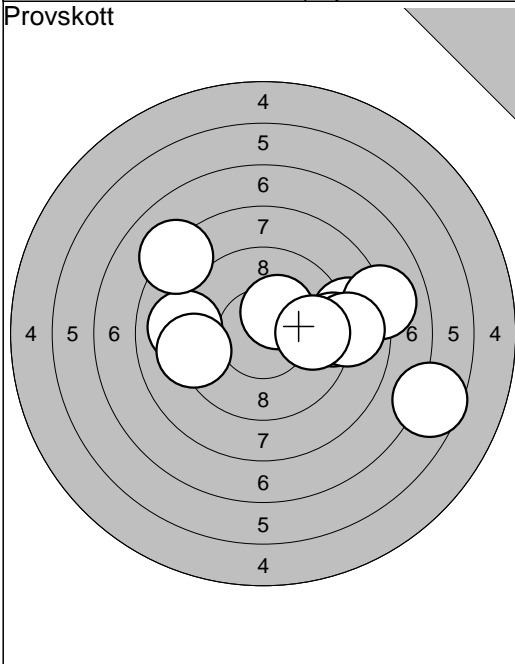

1: 8,8	→
2: 9,1	←
3: 8,0	→
4: 10,3*	↗
5: 9,2	→
6: 8,9	→
7: 9,2	←
8: 8,2	↖
9: 9,7	→
10: 6,6	↘
Serie:	84,0
Summa:	0,0

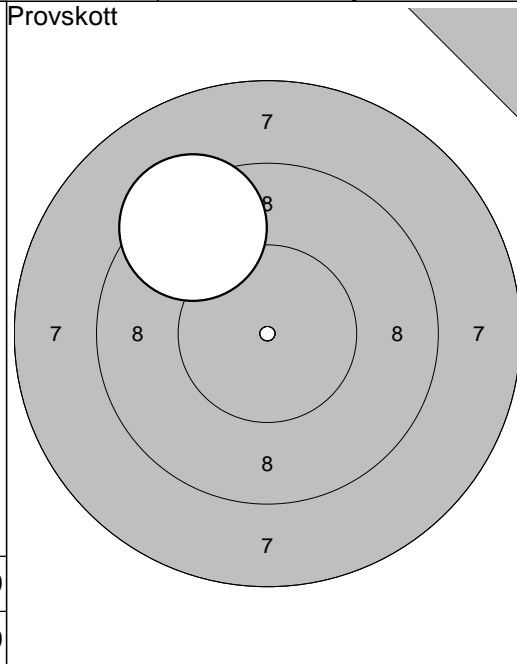

11: 9,4	↗
Serie:	9,0
Summa:	0,0

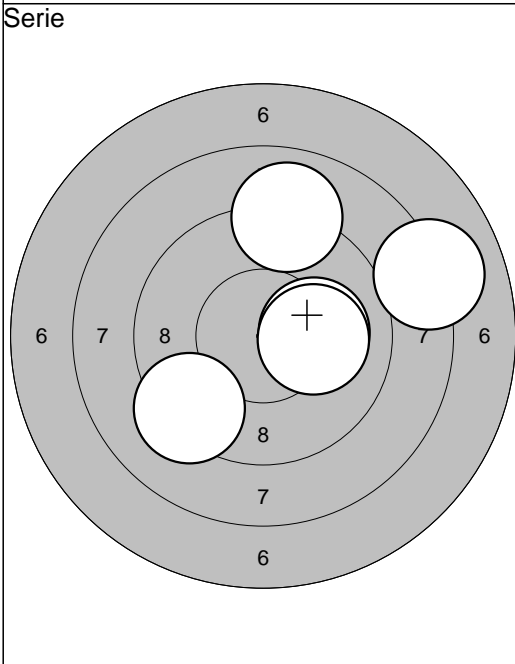

1: 9,0	↗
2: 10,1	→
3: 10,1	→
4: 8,1	→
5: 9,3	↙
Serie:	46,0
Summa:	46,0

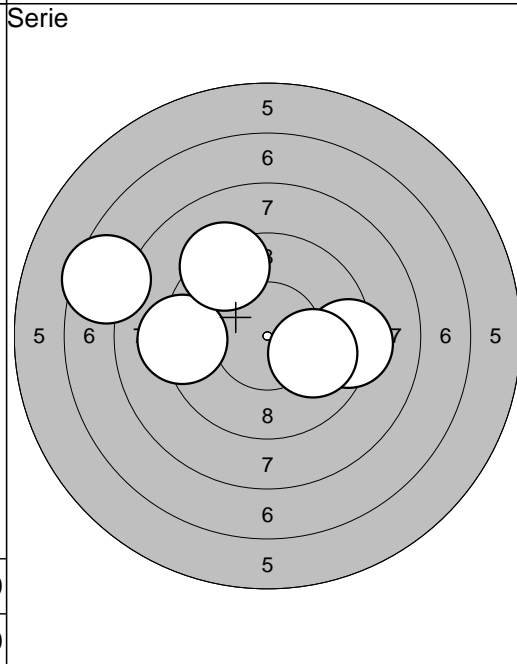

6: 9,2	←
7: 9,3	↗
8: 9,3	→
9: 7,5	↖
10: 10,0	↘
Serie:	44,0
Summa:	90,0

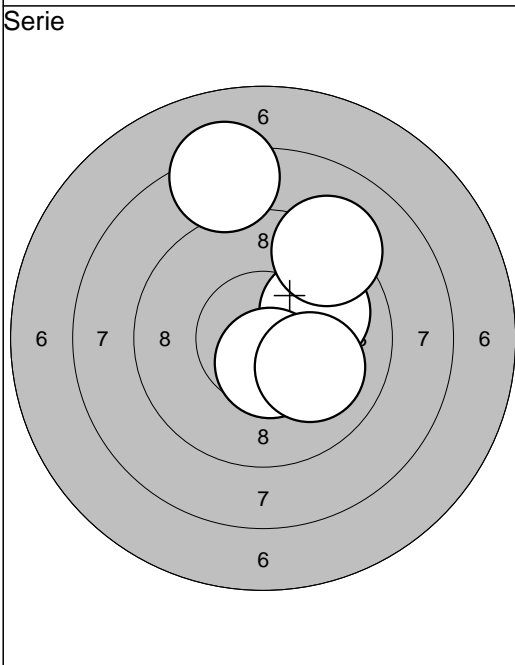

11: 10,0	→
12: 10,5*	↘
13: 9,2	↗
14: 8,3	↑
15: 10,0	↘
Serie:	47,0
Summa:	137,0

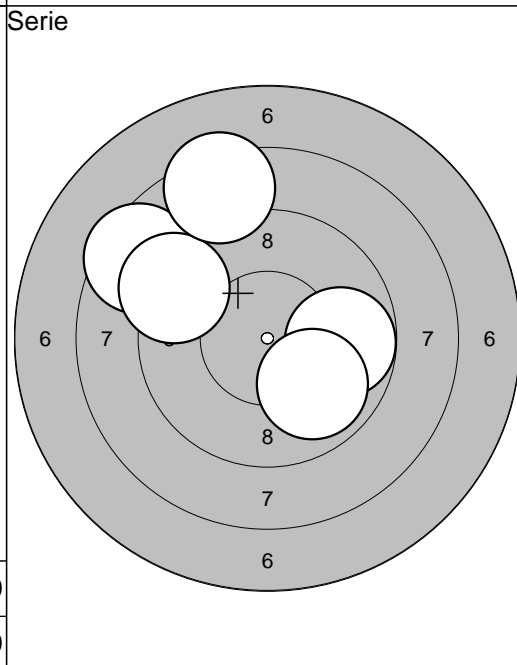

16: 8,5	↖
17: 9,8	→
18: 9,2	↖
19: 8,4	↑
20: 9,9	↘
Serie:	43,0
Summa:	180,0

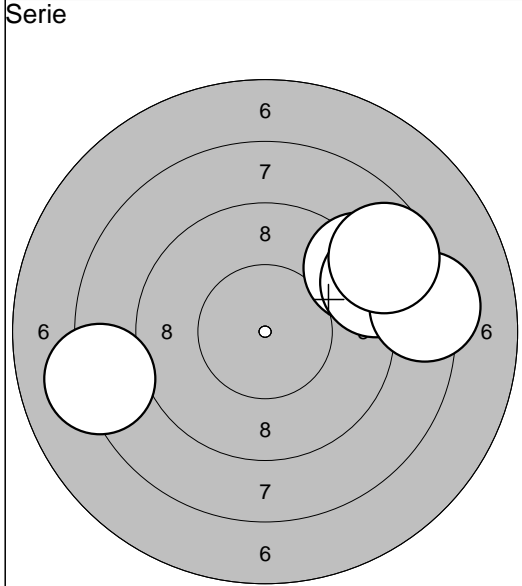

- 21: 9,1 ↗
- 22: 9,0 →
- 23: 8,2 ←
- 24: 8,3 →
- 25: 8,7 ↗

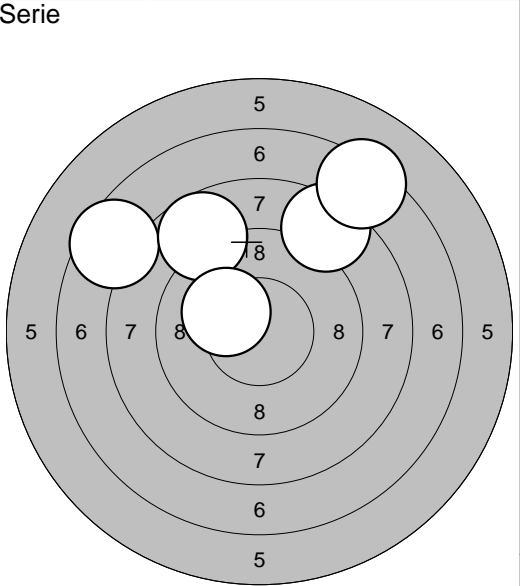

- 26: 8,5 ↗
- 27: 7,5 ↖
- 28: 8,7 ↗
- 29: 7,3 ↗
- 30: 10,2* ↖

Serie: 42,0
Summa: 222,0

Serie: 40,0
Summa: 262,0

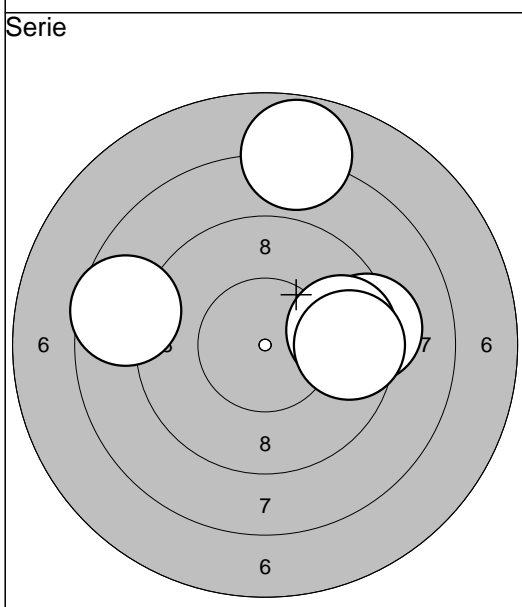

- 31: 7,8 ↑
- 32: 9,3 →
- 33: 8,6 ←
- 34: 9,7 →
- 35: 9,6 →

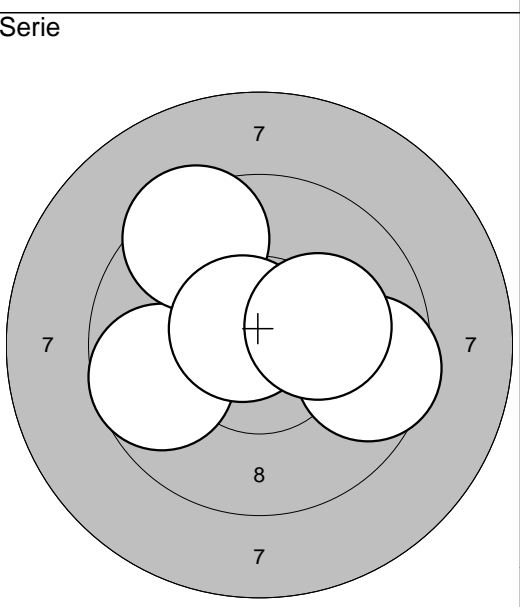

- 36: 9,7 ←
- 37: 9,6 →
- 38: 9,4 ↗
- 39: 10,7* ↗
- 40: 10,2* →

Serie: 42,0
Summa: 304,0

Serie: 47,0
Summa: 351,0